

# user's manual

982



# CONTENTS

user's manual .....	1
01 introduce .....	4
02 Product Overview (Hardware Description) .....	4
2.1.Port Function Description .....	4
2.2.Front-end port description .....	6
2.3.Forward button description .....	6
2.4.Remote control instructions .....	8
03 Installation and Configuration Guide .....	9
3.1. Security warning.....	9
3.2. installation instructions.....	9
3.3. Switching system description .....	13
3.4. OPS computer configuration options .....	14
3.5. OPS computer cable .....	14
04 System software description.....	16
4.1. main interface.....	16
4.2. System Settings .....	19
4.3. Apps list .....	25
4.3.1.Umind.....	25
4.3.2.DMS .....	31
4.3.3.UFile.....	32
4.3.4.tranScreen .....	34
4.3.5. WPS software .....	35
4.3.6.App Store .....	36

4.3.7.UPlay Video Player .....	36
4.3.8.UFreeze .....	37
4.3.9.Camera .....	40
4.3.10. Split Screen .....	41
4.3.11. URecord.....	41
4.3.12. Ucut.....	43
05 Warranty Terms (Three Guarantees Service Terms) .....	44
06 product certification .....	45

# 01 introduce

●This manual is for all all-in-one computer users and serves as a reference for beginners.

●If you have any trouble or questions, please contact our manufacturer:

<https://www.riotouch.com>

## 02 Product Overview (Hardware Description)

This document aims to clarify the basic functions and operation methods of the conference machine, so that users can get familiar with each function more quickly;

This product is an interactive conference machine with rich system functions and application functions. The basic usage methods of each function are introduced one by one below.

### 2.1. Port Function Description

982 (subject to physical goods)

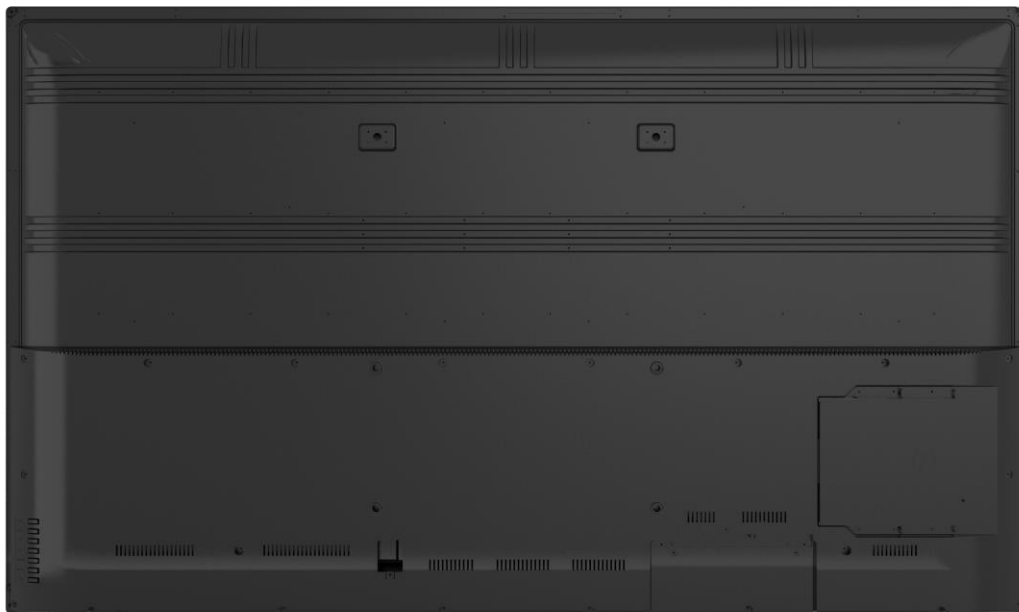









T-USB LAN IN YPBPR AV\_IN AV\_OUT AUDIO IN

VGA EARPHONE









USB 2.0 USB 3.0 RS232 HDMI 1 HDMI 2 SPDIF OUT

T_USB	Connect external devices to the panel for touch
LAN IN	Used for data transfer. The most common application is the network card interface.
YPBPR	Component video interface for transmitting analog HD video signals
AV_IN	Audio and video input port, an interface for receiving external audio and video signals
AV_OUT	Video output port, an interface for outputting audio and video signals
AUDIO IN	Audio input interface, external audio input jack, can input other sound sources to play sound
VGA	VGA video input interface is one of the common video input interfaces on the monitor
EARPHONE	Headphone jack
USB 2.0/3.0	Single USB port for connecting external storage devices on Android
RS232	The RS232 port can be used for external devices
HDMI 1/2	HDMI signal output, export HDMI signal to other devices for playback
SPDIF	This is an audio fiber optic interface, which requires corresponding peripherals to function. It transmits audio signals through fiber optic cables to the power amplifier.
HDMI IN	HDMI input can send uncompressed audio and video signals

## 2.2. Front-end port description

picture	function declaration
	Connects to external storage devices, such as USB drives
	Connects to external storage devices, such as USB drives
	Connects to external storage devices, such as USB drives
	Connect external devices to the panel for touch
	HDMI input can send audio and video signals
	HDMI input can send audio and video signals
	HDMI input can send audio and video signals
	Full USB Type-C

## 2.3. Forward button description

picture	function
	Red means standby, blue means on
	Turn on the switch
	Select signal source input
<b>ECO</b>	energy conservation
	primary menu
	Setting
	Volume up
	Volume down
	Help users turn devices on and off quickly
	Fingerprint lock screen and unlock screen



## 2.4. Remote control instructions

### Use physical items

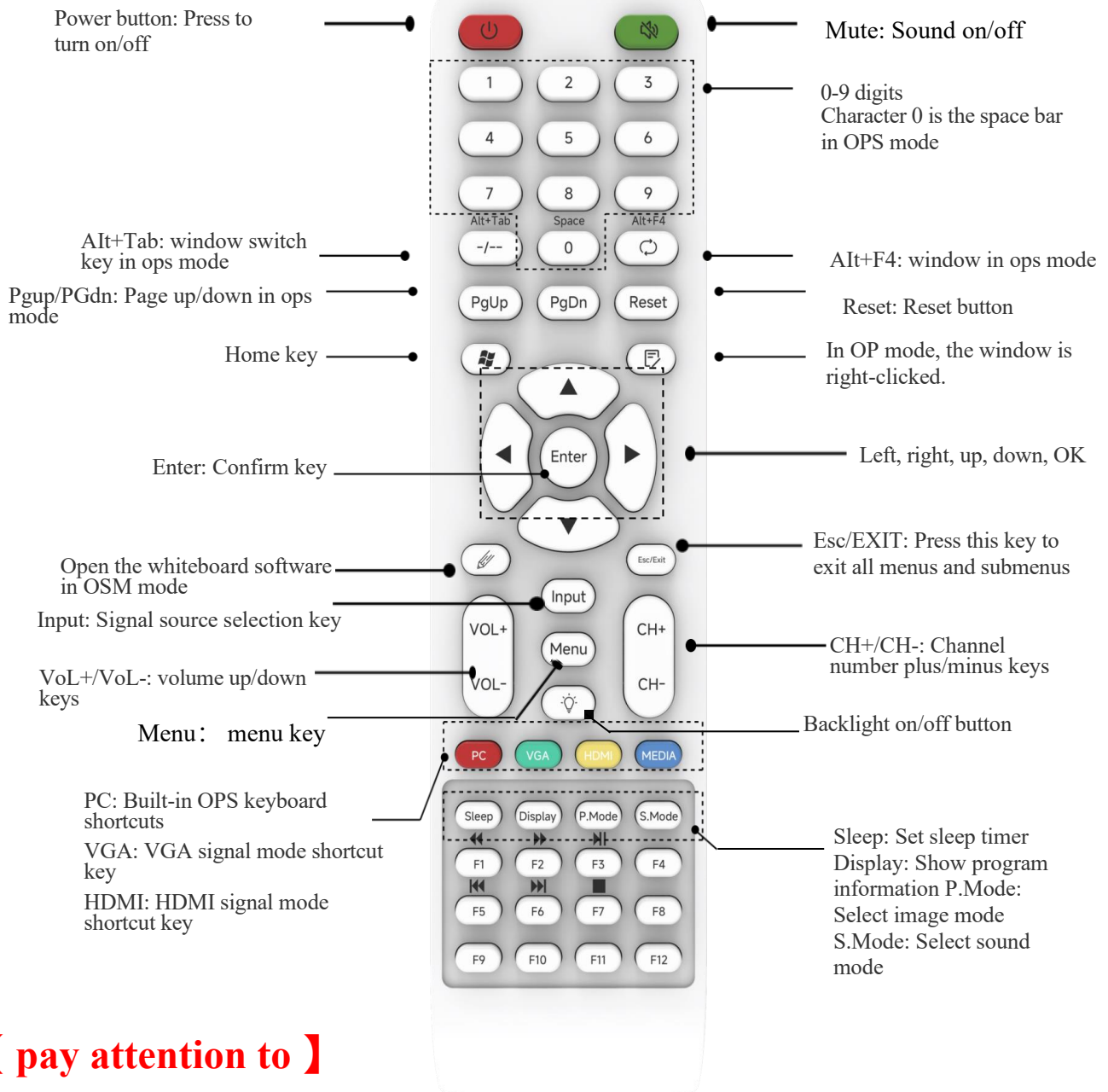

### 【 pay attention to 】

- To ensure the remote control works properly, replace the battery and try again if it doesn't work.
- Do not mix new and old batteries or batteries of different models.
- When the battery power is weak, the electrolyte will leak, which will damage the remote control. Once the power is weak, replace the battery as soon as possible.
- If you do not use the remote control for a long time, remove the battery to prevent electrolyte leakage.
- If you do not use the all-in-one machine for a long time, unplug the power supply.

# 03 Installation and Configuration Guide

## 3.1. Security warning

### Safety Warning: Grounding Instructions

This product must be electrically connected to ground. If a fault occurs, proper grounding reduces the risk of contact. The power cord is equipped with a grounding conductor and must be connected to a properly installed and grounded outlet.

Grounding protection (when the entire machine leaks current, the leakage circuit breaker will trip to cut off power promptly). Induced current can be conducted through the grounding wire to prevent electric shock.

#### **【 matters need attention 】**

1. When using a three-core power plug, ensure a good connection of the ground wire;
2. It is forbidden to dismantle the ground wire or modify the power socket without authorization;
3. The equipment shall be connected to a grounding system conforming to national safety codes;
4. If your environment lacks a grounding wire, we recommend having a licensed electrician assess and install one.

### Security Warning: Installation Instructions

1. Before installation, please read this manual carefully and follow the steps strictly to ensure the installation process is accurate and error-free.

2. Installation must be performed by at least two people and must be handled by qualified technicians. Improper installation may cause safety problems such as display drop and failure, endangering the safety of personnel and equipment.

3. The wall where the installation is to be mounted must be constructed with a solid material such as solid bricks or concrete. If you have any questions about the installation site, consult a professional technician before installation. Do not blindly construct to avoid unnecessary losses.

## 3.2. installation instructions

### Load-bearing bearing

Users can install the panel on the wall or mobile bracket according to their needs.

When installing with a mobile stand, select one from the manufacturer's accessories. If you purchase it yourself, make sure

The bracket must be able to support at least four times the weight of the panel and stabilize it.

When using wall-mounted installations, the mounting surface must be sturdy and capable of supporting loads, with a minimum load capacity of four times the panel's actual weight. When the mounting surface is a building wall or roof, it must be solid brick, concrete, or equivalent structural materials with comparable strength. If the mounting surface consists of loose materials (such as old-style house bricks, wood, solid bricks, etc.), metal, non-metallic structures, or excessively thick decorative layers that lack sufficient strength, appropriate reinforcement and support measures should be implemented to prevent potential safety hazards.

**heat radiation**

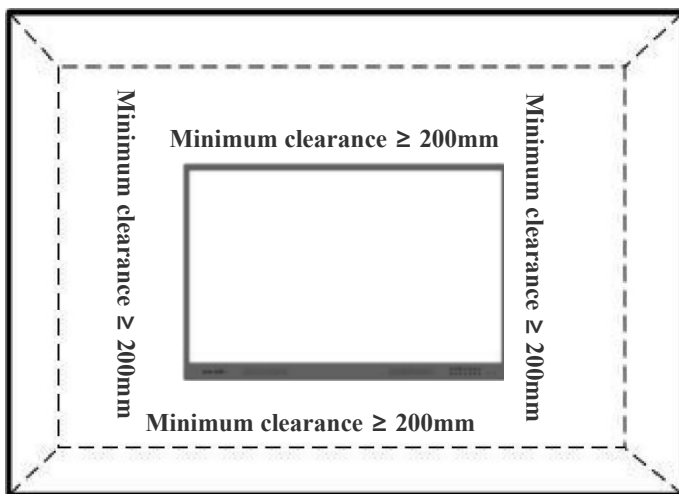

**【 pay attention to 】**

When wall mounting, the bolt should be embedded to a safety depth of more than 10 mm, and the ventilation hole should be ensured not to be blocked, so as to maintain the normal ventilation condition of the equipment, and ensure the safety and stable performance.

ask	Safety distance between the panel and the mounting surface (mm)			
	Left and right	top	bottom	the back
Monitor power ≥ 100W	200	200	200	100

# rack-mounting set

Wall component size:

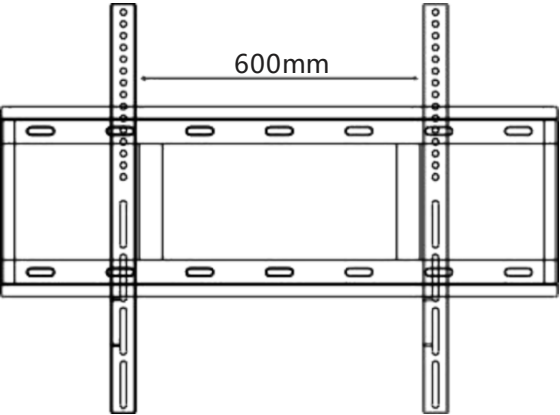

65"

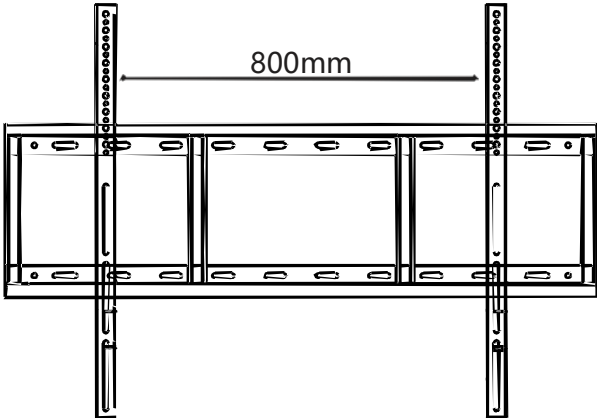

75" | 86"

Installments:

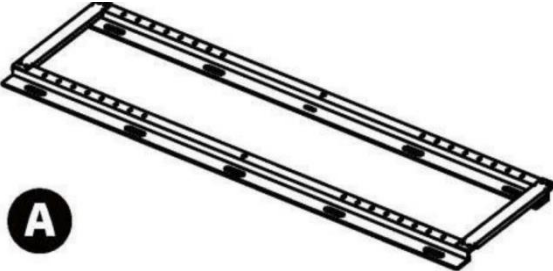

**A**

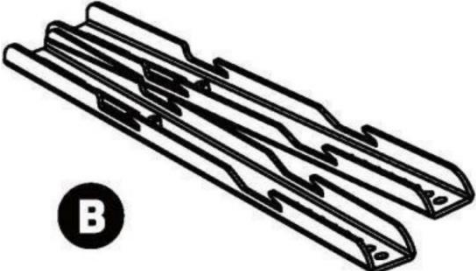

**B**

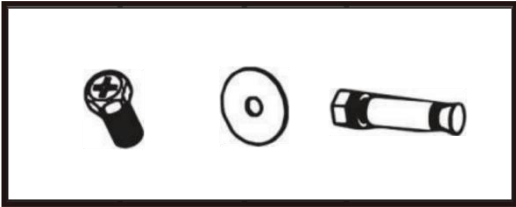

**C**

A	Wall panel (wall panel)	1
B	support	2
C	M8 fixed screw	4
	setscrew	8

## installation notice

1. Before installation, please read this manual carefully and strictly follow the steps to ensure accurate installation.

2. Installation must be performed by at least two people and must be handled by qualified technicians. Improper installation may cause display drops, malfunctions, and other safety issues, endangering personnel and equipment.

3. The wall where the installation is to be mounted must be constructed with a solid material such as solid bricks or concrete. If you have any questions about the installation site, consult a professional technician before installation. Do not blindly construct to avoid unnecessary losses.

## Installation Steps

1

1. Drill 8 corresponding holes at the same position on the wall as shown in the diagram. The hole diameter should be smaller than the screw diameter. (Note: The hole diameter on the wall should be less than 10mm)
2. Take 8 expansion screws and fasten the wall panel tightly to the wall to ensure it is not loose.

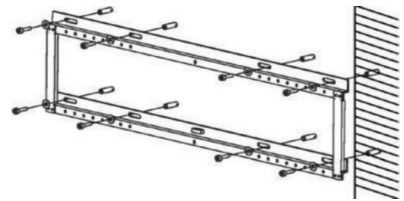

wall

2

Stands (two on each side)

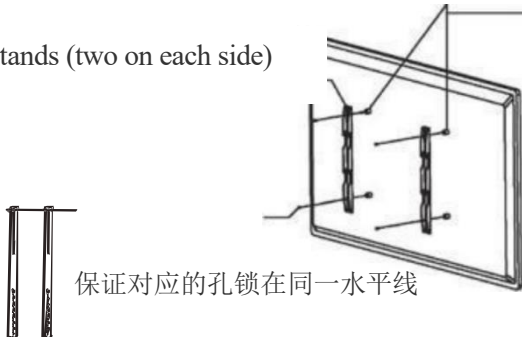

保证对应的孔锁在同一水平线

First, secure the upper hole, then tighten the M8 screws at four rear display positions.

【 pay attention to 】

The bracket must be installed strictly according to the diagram above. During bracket installation, ensure all mounting holes are aligned on the same horizontal plane to guarantee a secure and precise installation.

3

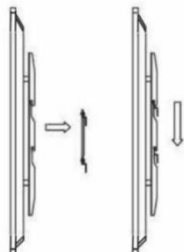





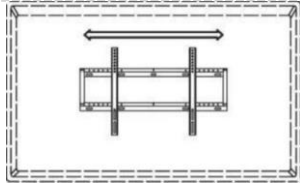



Note: After completing steps 1 and 2, install the fixed monitor on the wall.

4



Check that the wall mount connector is securely locked onto the wall panel. The display can be adjusted left and right.

## fittings of a machine

picture of real products	item name	quantity (pcs)
	telecontroller	1
	power line	1
	HDMI cable	1
	TOUCH Touch Line	1
	WiFi antenna	1
	All-in-one wall-mounted unit (machine) (set)	1
	All-in-one machine screw (set)	1
	Whiteboard Pen (Orange)	4

## 3.3.Switching system description

### Startup process

1. Turn on the device by pressing the power button on the remote control or panel, and the indicator light will change from red to blue.
2. Dual system enables one-touch power-on with just the power button press

## Shut down method



1. Press the power button on the panel to enter the normal shutdown process
2. Dual system features one-touch power-off with just a press of the power button
3. After the computer is completely shut down, it automatically enters standby mode

## 3.4.OPS computer configuration options

The built-in OPS is connected as shown below. The connection is complete. Simply plug in the power cord and power on the device.



## 3.5.OPS computer cable

<p>1. HDMI Connect the HDMI port of the touch TV all-in-one device to the PC's HDMI port using an HDMI cable (refer to the port function specifications for details).</p>	
<p>2. Type-C Use Type-C to transfer audio and video, charge, and connect external storage devices to read files</p>	
<p>3. Audio cable Use a 3.5mm audio cable to connect the PC's audio output to the TV's audio input (refer to the port function description for details).</p>	

#### 4. Touch the USB cable

Connect a standard USB cable to the USB port on the all-in-one TOUCH printer, then link the other end to an external USB port (refer to the front port specifications for details).



# 04 System software description

## 4.1.main interface

The main interface features a whiteboard, file manager, Chrome, and a custom list of frequently used apps. These are the most commonly used functions.

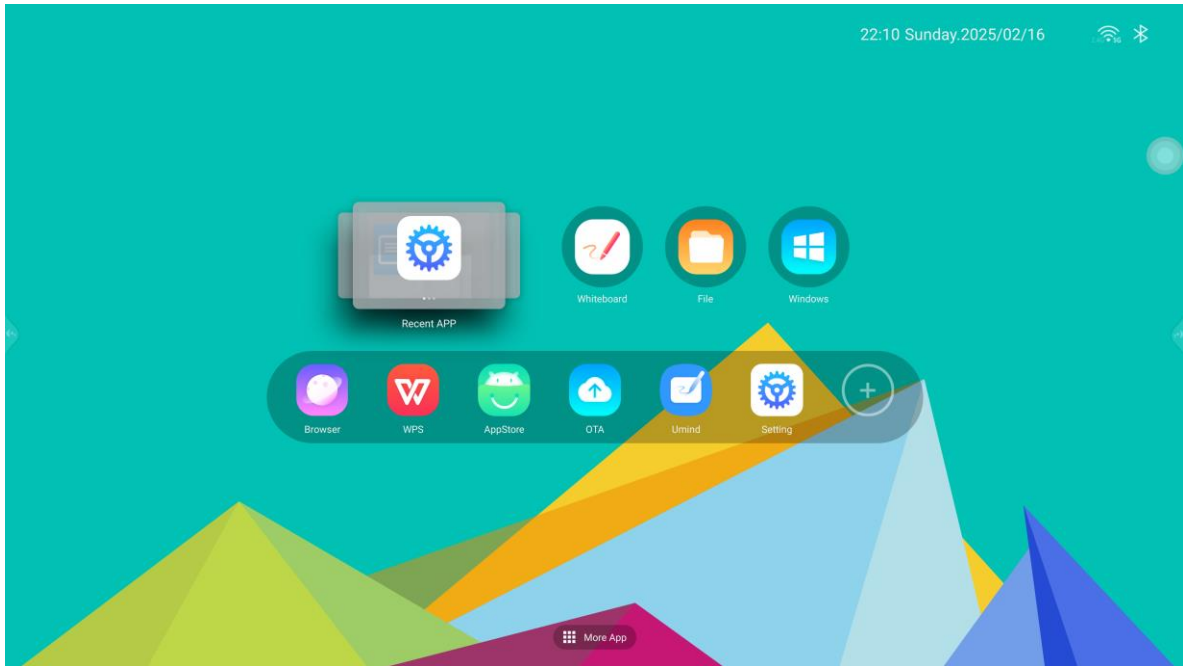

For more features on the home screen, see the following diagram: ① Control Center ② Top status bar ③ Main function icons ④ More apps ⑤ Side bar ⑥ Bubbles ⑦ Signal source

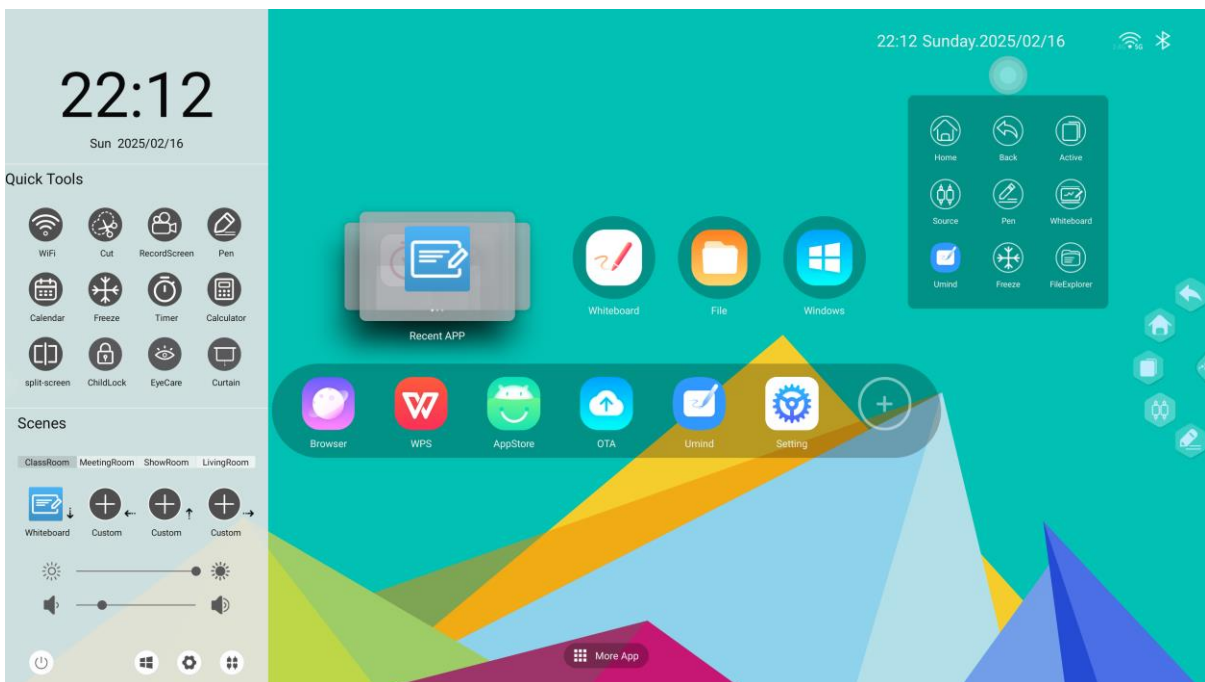

## ① control center :

Quick access to WiFi, cut, screen recording, pen, calendar, freeze, timer, calculator, and more. Background color themes can be changed: purple, blue, green. You can also customize the OEM background.

Different scenarios: classroom, meeting room, exhibition hall, and living room. You can customize different gestures for each scenario to launch different apps from the top, bottom, left, and right.

Bottom toolbar: Power, OPS, Settings, Input Source.

Tong Lock :

Tap the lock icon to lock the screen. Tap the lock icon again to enter the password (Super Password 2580) to unlock.

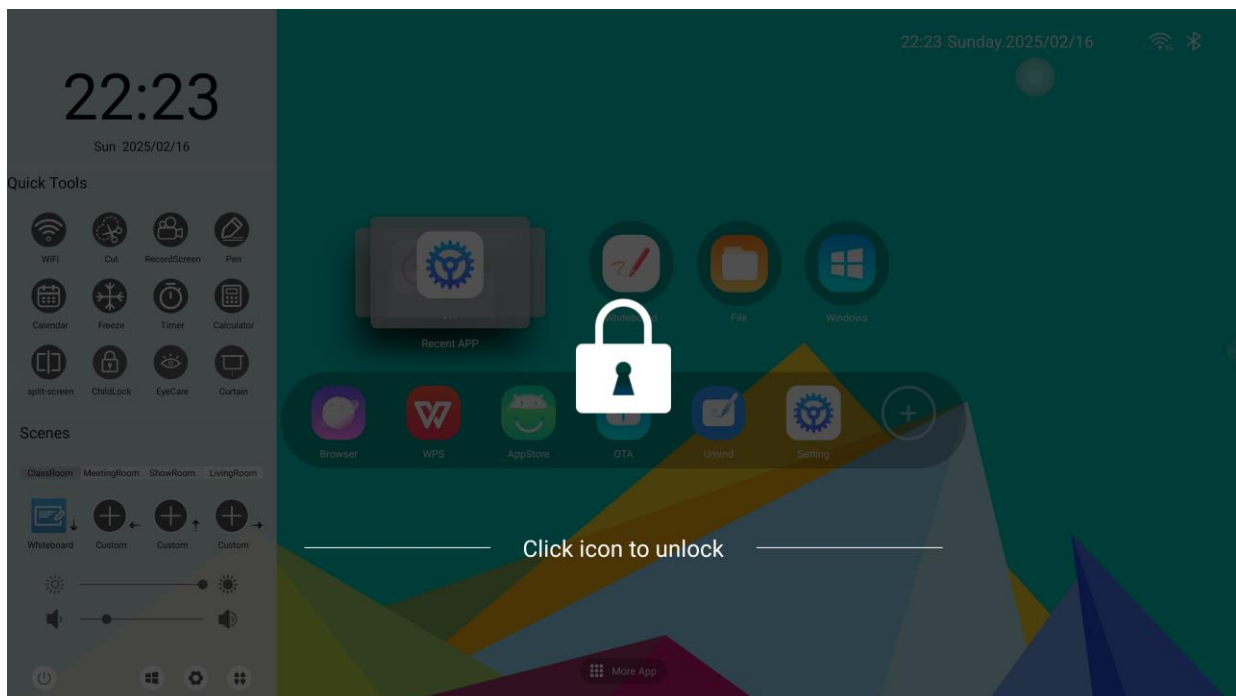

## ②Top status bar

You need to enable the relevant features in the settings interface, such as display time, wallpaper, and internet.

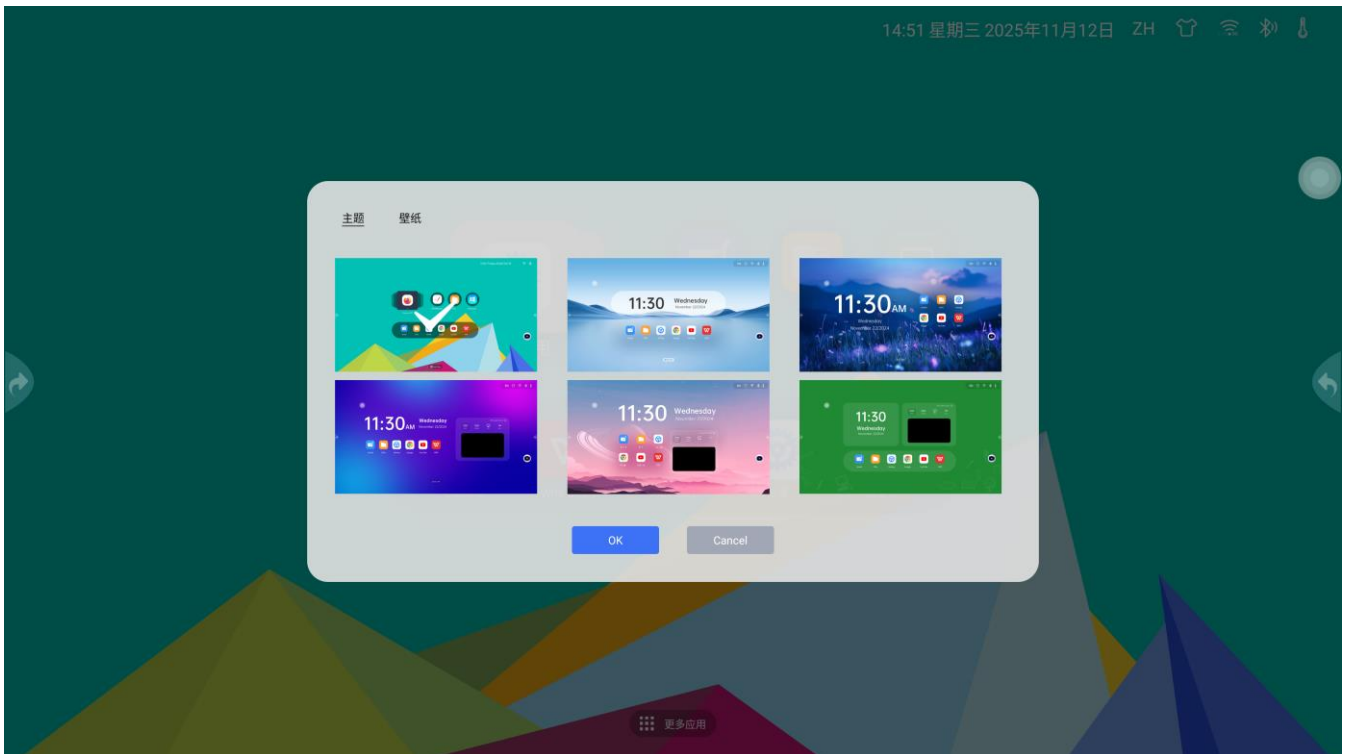

### ③ Main function icon:

Default applications: Whiteboard, Google Chrome, Files, OPS.

Custom applications: Chrome, WPS, AppStore, Upgrade, custom.

### ④ More :

Click More Apps to view more apps

### ⑤ side bar :

The sidebar will automatically hide after 3 seconds if no action is taken when expanded.

1. Return: Go back to the menu above.
2. Home: Return to the home screen.
3. Task Management: Check the running apps in the background, then tap the bottom 'Clear Up' button to close all active apps.
4. Signal source: Click here to display the signal source list
5. Annotation: Quickly activate the annotation feature to draw annotations on the screen



### ⑥ Bubbles:

Users can turn it on or off in the settings menu. It will appear when you long-press with three fingers after startup.

9 features that users cannot set have been fixed. Click the button to add the application you want, as shown in the image below:

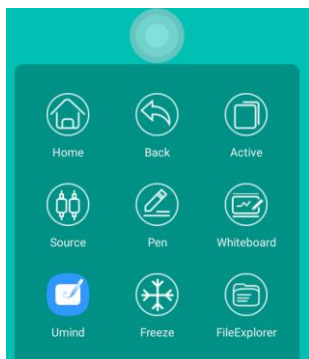

## ⑦ signal source :

Click the button  to access the input signal source list. Select the default options: PreHDMI、 OPS、 HDMI1 、 HDMI2、 VGA、 HDMI3、 DP、 PreTYPE C or TYPE C. For multi-channel setups, an expansion board is required

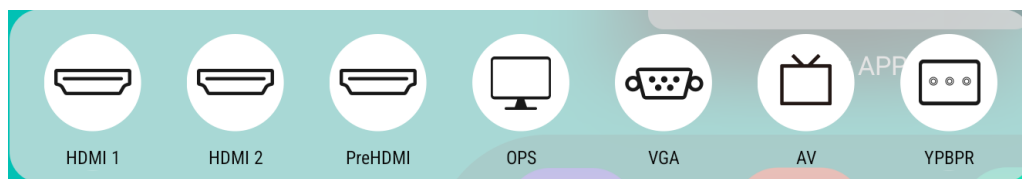

**Note: The actual pre-order configuration is subject to the final order.**

## 4.2. System Settings

It consists of four parts: the regular part, the network connection device, the system, and the device.

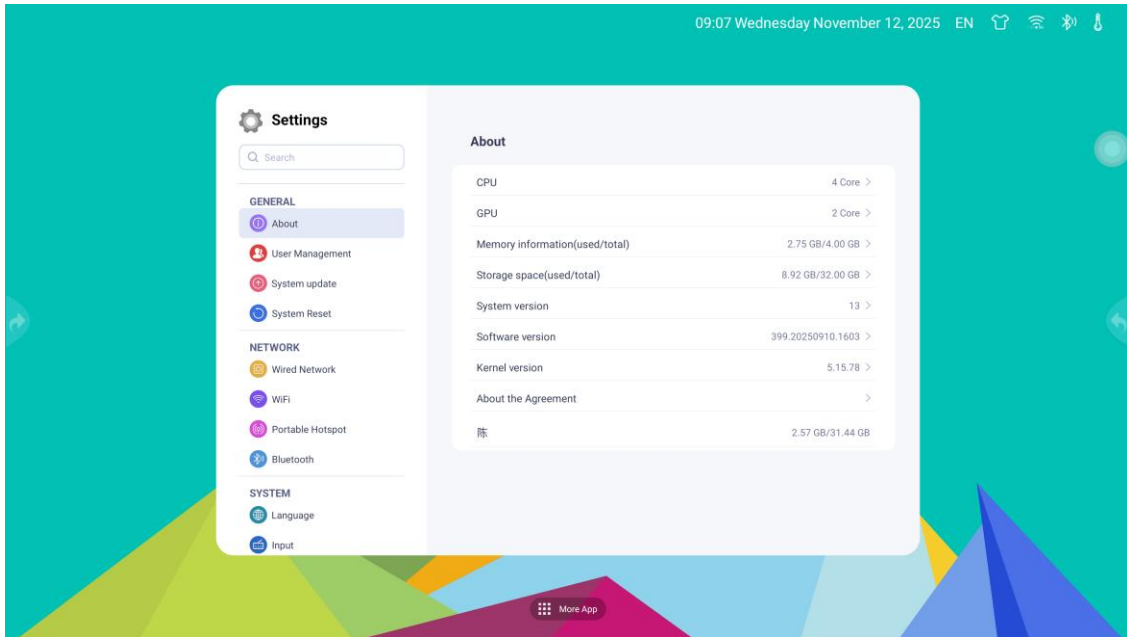

On the home screen, click More Apps-> Settings to access the system settings interface.

General Settings	
about	Hardware configuration, software version, and OEM customer information
user management	Switch user, fingerprint, card, and password management
system update	Local and online updates
Restore default	Clear data and restore the system to factory settings
NCE	
Wired network	View information such as wired network IP
wireless network	Click to set up Wi-Fi
Portable hotspot	Turn on hotspots, connect, and set up
Bluetooth	Bluetooth connection, refresh, and activation
system	
language	Click to set the language in Android
typewriting	The default is Sogou keyboard input and Gboard keyboard input. OEMs can add others.

Date and time	Click to set date, time, and other formats in Android
show	Eye protection mode, brightness, screen adjustment, color temperature mode, dark mode, external signal source display
sound	Volume control, analog microphone, audio input/output devices
APP	Click to view Android apps, third-party software removal, and more
Credentials storage	Trust Certificate Management
more	Floating ball, side bar, light sensor, five-finger screen dimmer, three-finger follow function switch
equipment	
equipment	Camera Settings, 3-in-1 sensor
Channel Settings	Boot channel, blue screen with no signal, no signal return, no signal standby
Schedule	Scheduled sleep, automatic sleep time, power button, system startup, scheduled power on/off
Security Settings	Set passwords, power-on lock screen, USB lock, app lock, and touch lock switch

## Version information:

View the current device hardware configuration and software version information

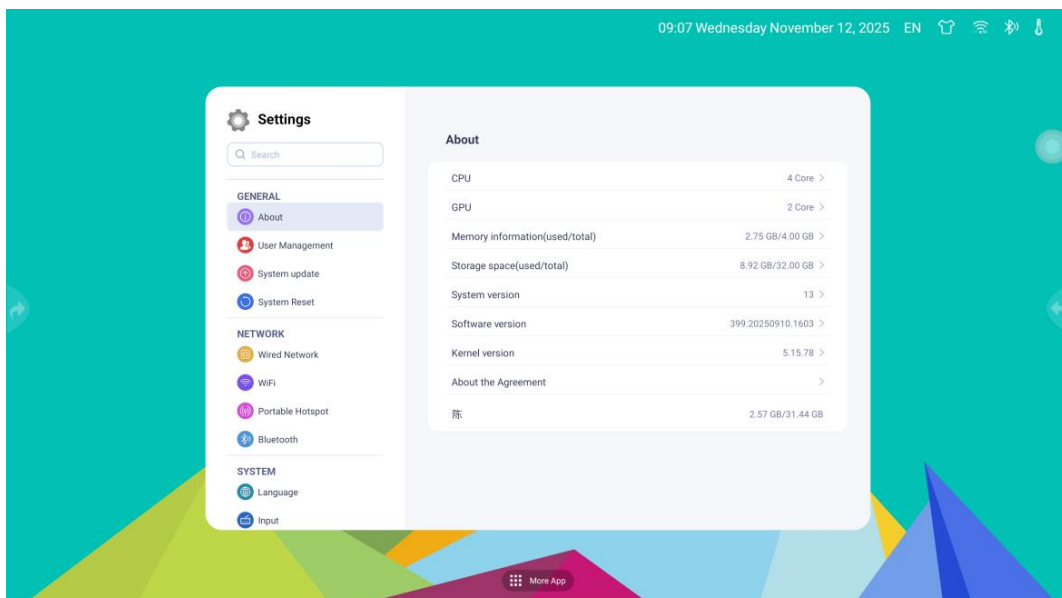

## OTA online upgrade:

Software updates are available in two modes: online and local. Select 'Online Upgrade'. If the system confirms your firmware is already up to date, no upgrade is required. If it shows 'Latest version is XX', click the upgrade button to proceed.

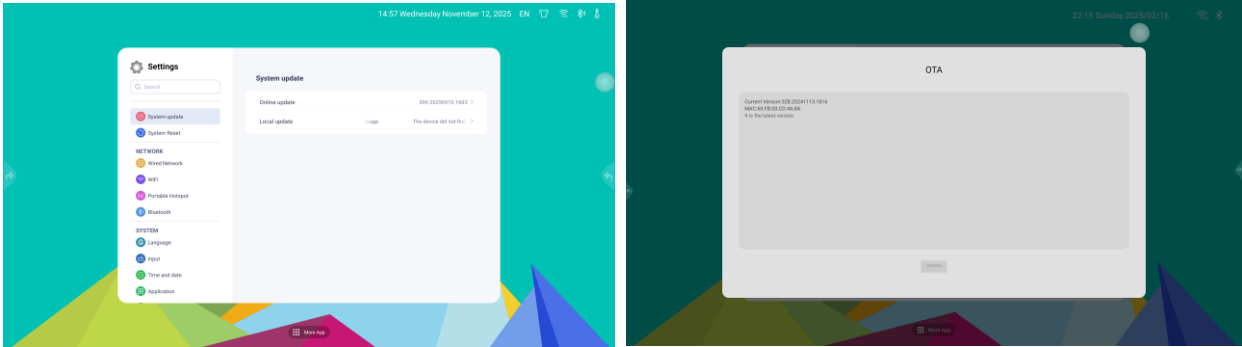

## wifi:

Check the Settings-> WiFi interface. If the WiFi list is not displayed, switch to another category (e.g., wired network), then switch back to wireless network. The list will appear. For the first connection, enter the password manually; subsequent connections will be automatic.

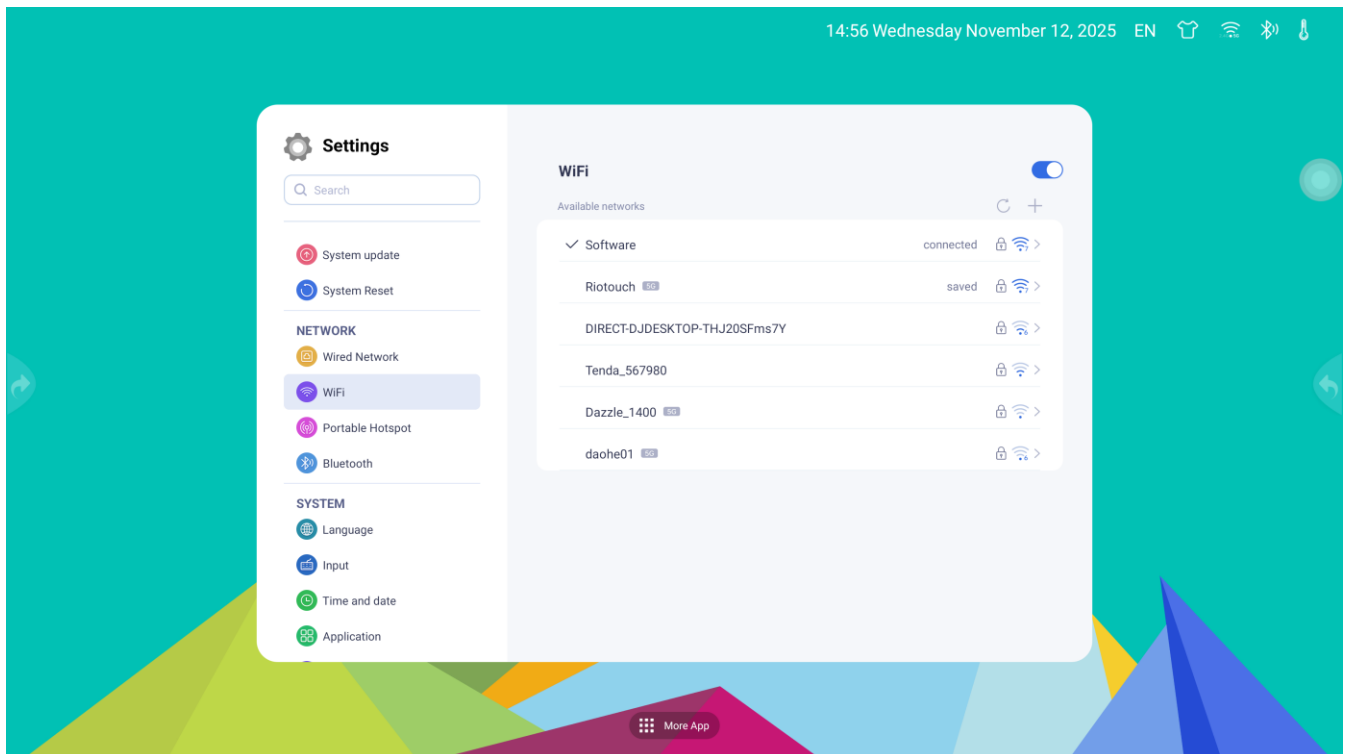

## Bluetooth device settings:

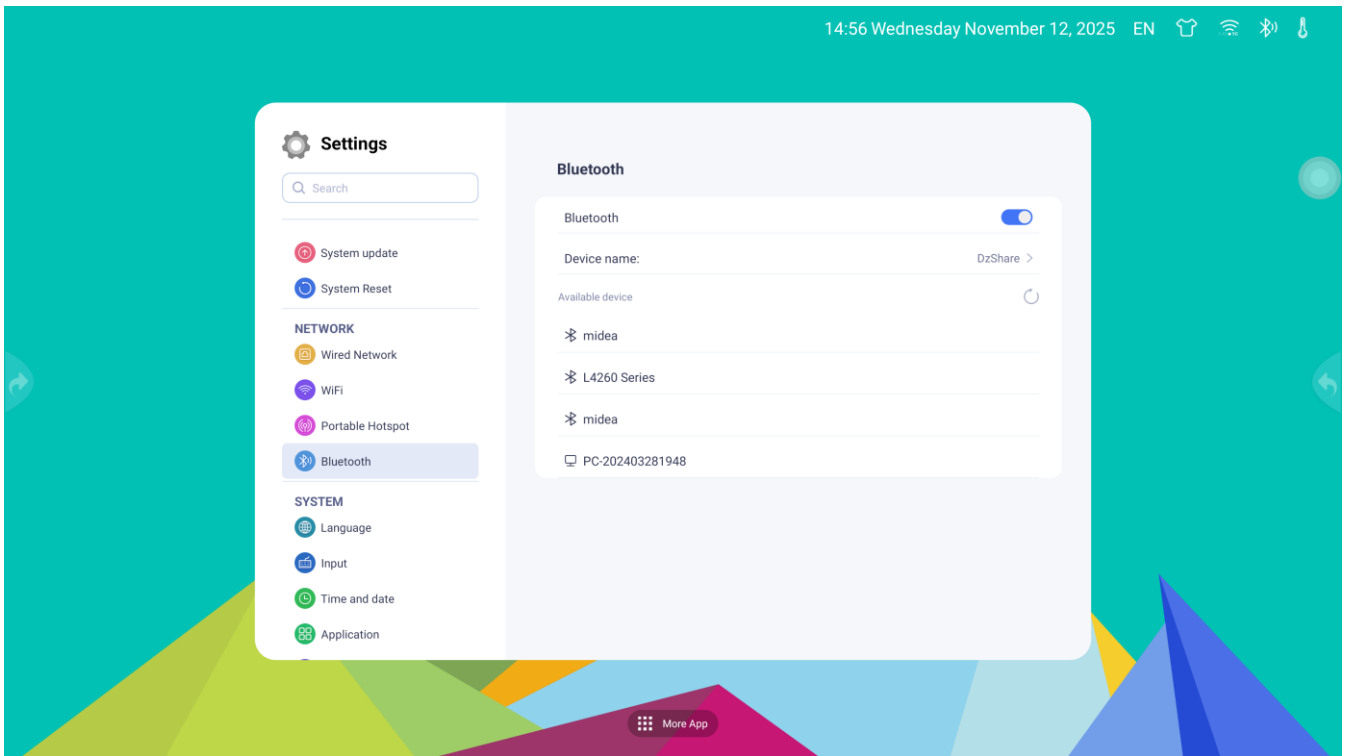

## lock screen :

The USB lock, app lock, and power-on lock share the same password. When the USB lock is enabled, a USB drive cannot be recognized by the device. After enabling the app lock, select the locked app, confirm, and then open it to enter the shared password. To use the power-on lock, restart the device and enter the password.

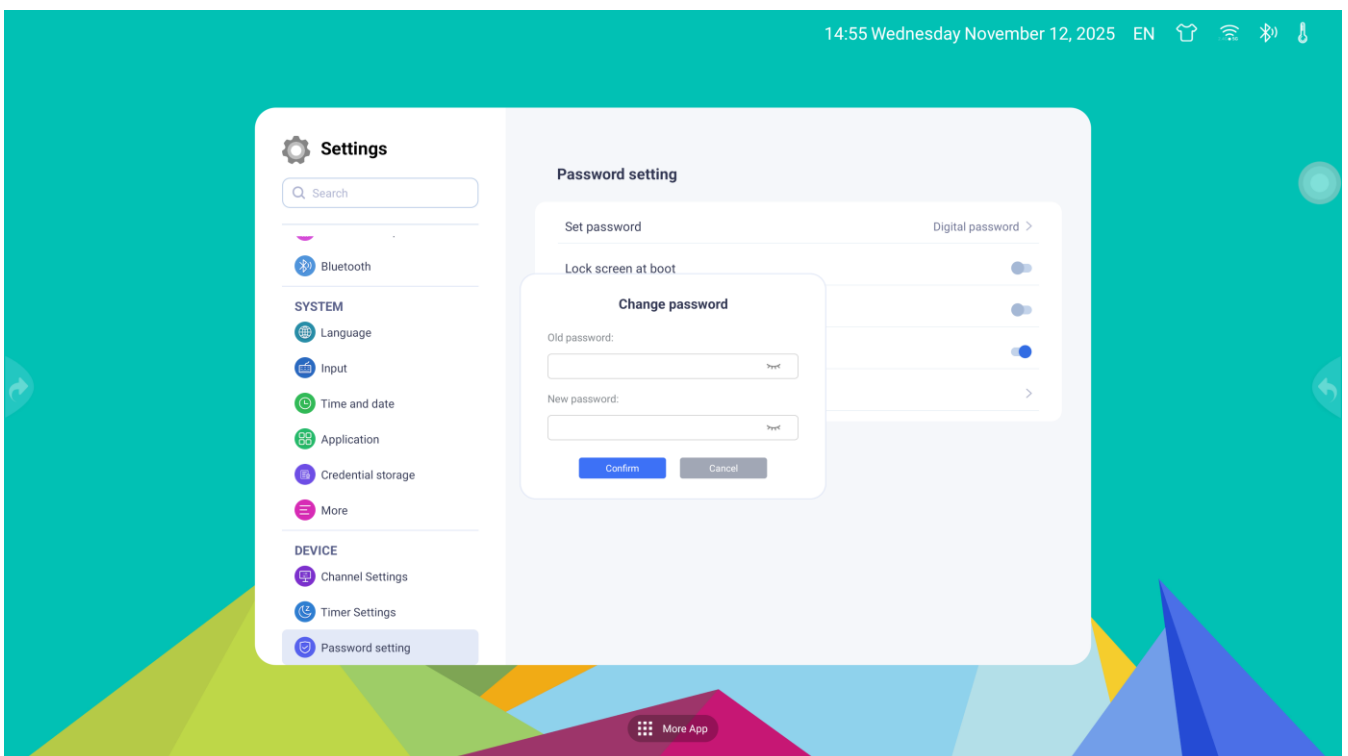

## More:

Set the floating ball, sidebar, and light sensor

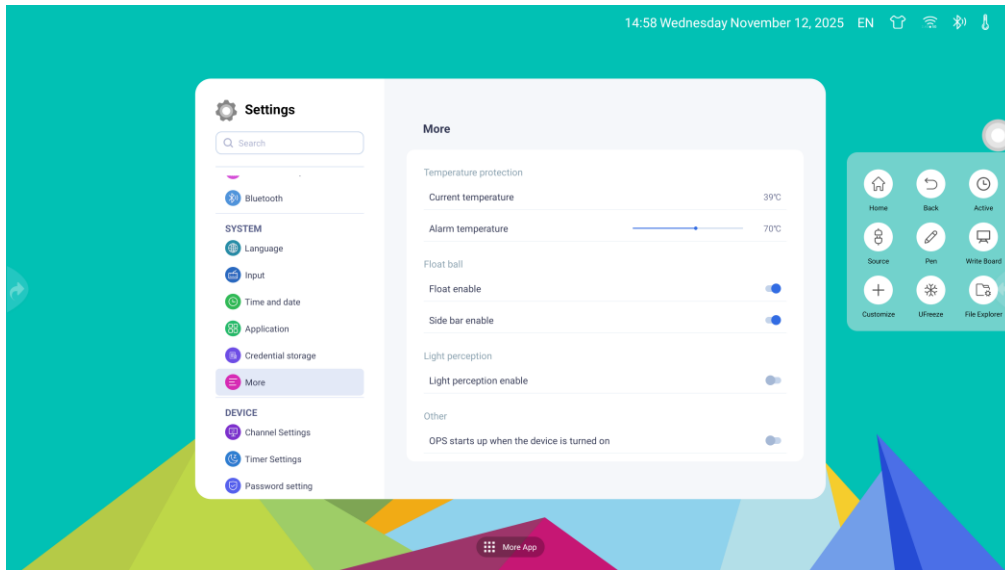

## Replace the startup/stop logo:

Replacement boot animation steps:

1. Extract the logo file to a USB drive or root directory,  
name: bootup.bmp (16-bit depth). logo: 1920\*1080 size  
name: bootvideo.mp4, Animation: 1920\*1080 size,
2. Press input+2580 on the remote.
3. Select "common setting" and choose "upgrade boot logo/video". Press enter on the remote to enter.
4. The system will automatically load the logo image.
5. Restart the device to apply successfully.

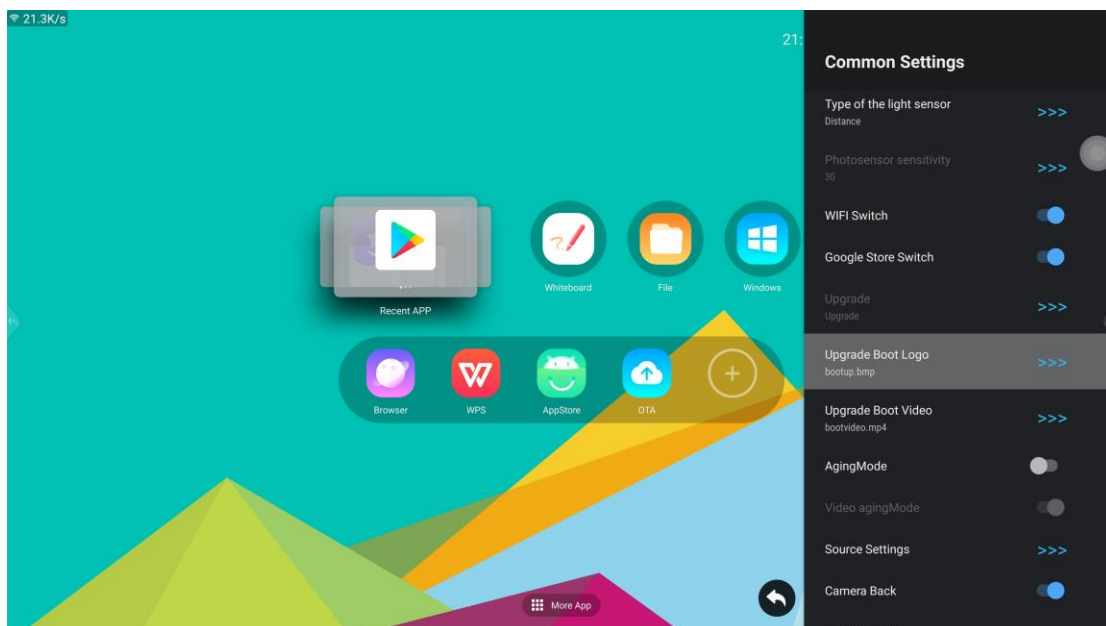

## 4.3.Apps list

### 4.3.1.Umind

Writing whiteboard software allows the writer to quickly write what he or she wants to think, more conveniently than any traditional writing.

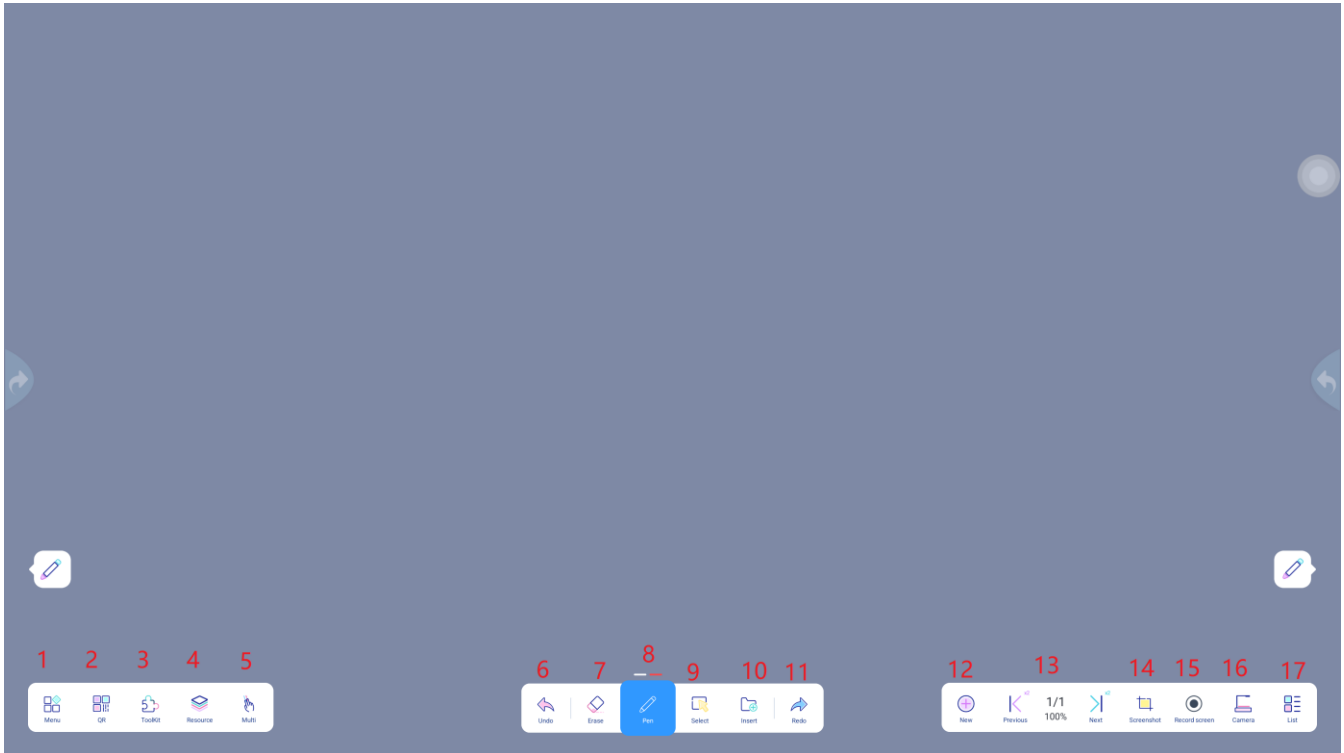

Basic Features	
1. Menu	The menu includes Open, Save, Export, Settings, About, and Exit.
2. QR code	Share this page or all pages (QR code)
3. Toolkit	Periodic table, courseware, 3D
4. resource	Teaching resources uploaded to the school account cloud platform
5. Fingers	Single/finger
6. Undo	Undo the previous action
7. Eraser	Delete, Select and Delete, Clear Screen with One Tap
8. Pen	Adjust the pen's writing style, thickness, and color

9. Select	The object is selectable.
10. Insert	Insert tools like rulers, comments, triangles, protractors, calculators, screens, timers, calendars, spotlights, and voting tools on the whiteboard interface. Edit editable tables and mind maps. Insert shapes, videos, images, and transfer files from your phone to the all-in-one machine.
11. Redo	Redo the previous action
12. New Page	Create next page
13. page turning	Page up/down
14. Screenshots	Screenshot the content to the whiteboard
15. Screen recording	Call the URecord software to record the whiteboard
16. Camera	Turn on camera
17. tabulation	Delete the page in the page preview

- ① Set basic whiteboard statuses, such as eraser activation, custom thresholds, and dark mode.

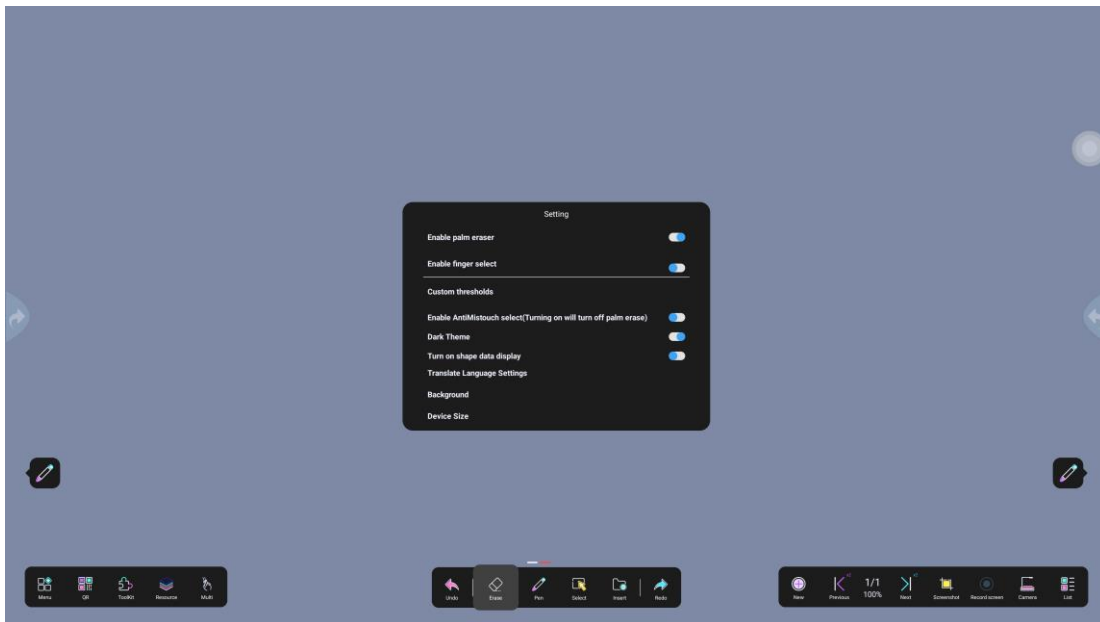

- ② Umind offers a variety of pens: regular, graphic, AI-powered (text), and simplified pens, allowing users to switch between them for writing. Users often need to adjust properties like color and thickness while writing.

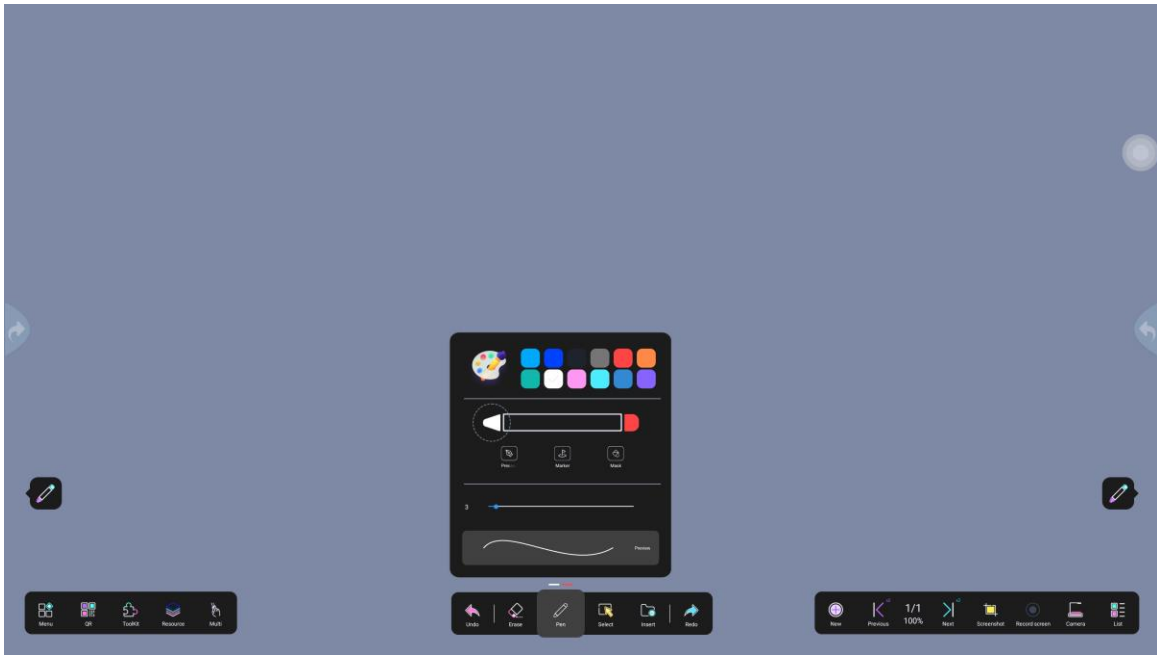

③ Ucourse is a dedicated teaching plugin embedded in UMind, featuring intuitive operation and strong classroom interactivity. It supports multimedia teaching formats including images, audio, and video, along with online classroom exercises. Teachers can use Ucourse to deliver real-time instruction across various subjects effortlessly. The plugin also supports PHET animation simulations, 3D resource presentations, periodic table animations, and multimedia courseware (audio, video, images).

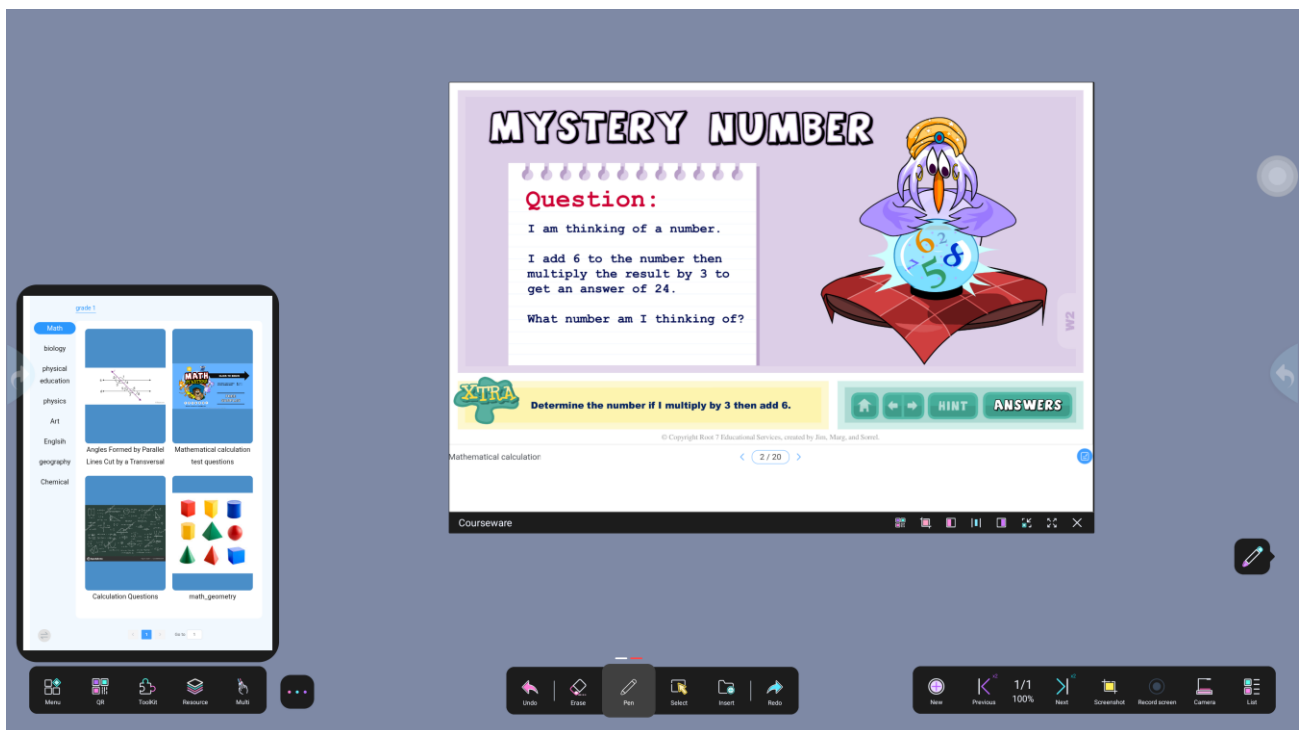

④ Insert functions provide chart, file, signal source, and other insertion methods. Files support multi-window preview, with adjustable window sizes in all directions. When minimized, the file can be retrieved from the drawer.

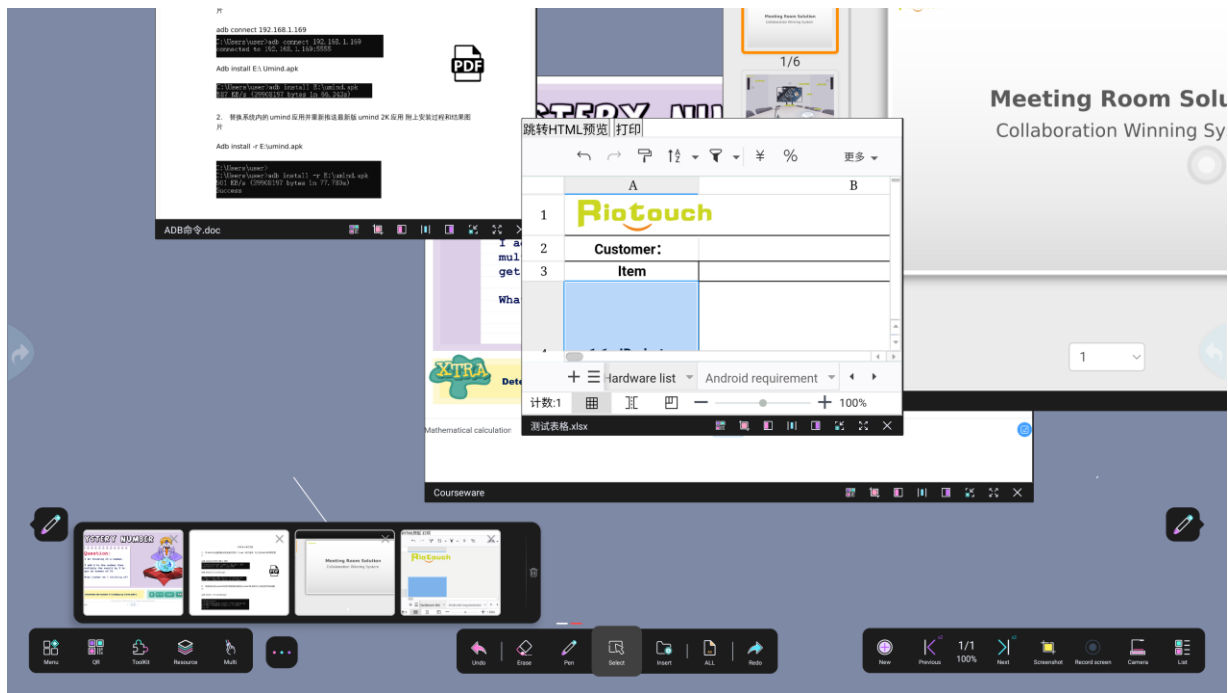



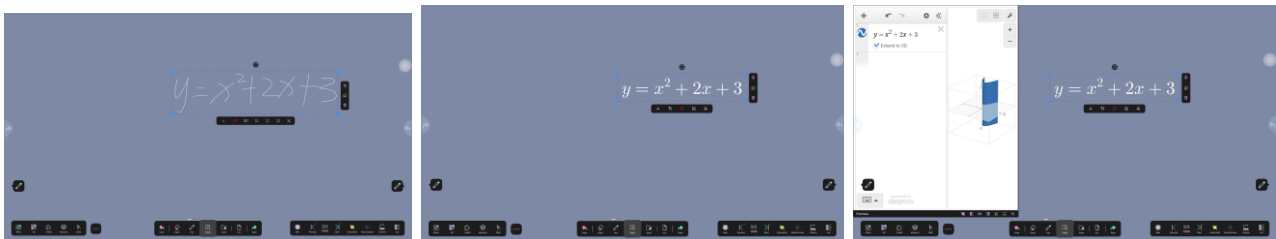

⑤ **Formula Recognition:** After writing a formula with the pen  function, select the formula and click to convert it to standard format. Click to generate a function graph from the standard formula. The left pop-up box supports custom variables and 3D display.

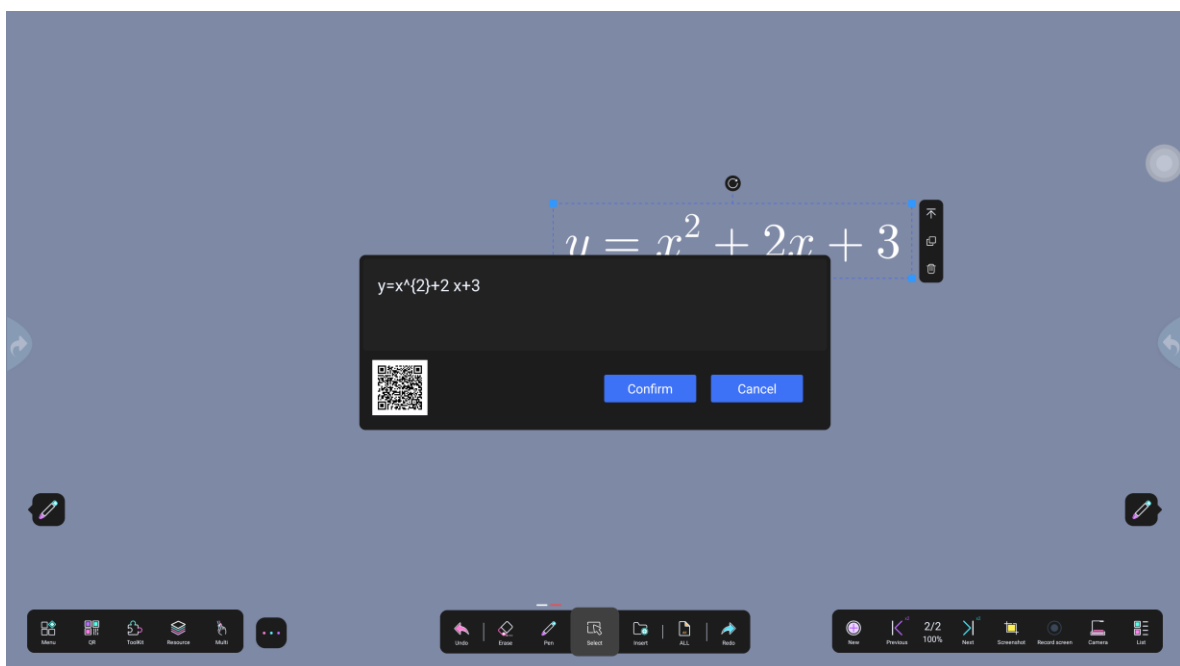

Click to modify formulas directly on your phone or edit them directly from the whiteboard.



## ⑥ character recognition

- After handwriting, you can convert it to standard text.
- Tap to  toggle case.
- Tap to  use voice input, paste, and edit text.
- Tap to  translate standard text into multiple languages.
- Click  to convert standard text (including translated text) to local voice (standard or variable speed playback)

Male, voice)

- Click Q to access online search services including Google, Microsoft, Wikipedia, Bing, Yahoo, and Yandex. After searching for images, you can drag and drop them into UMind.

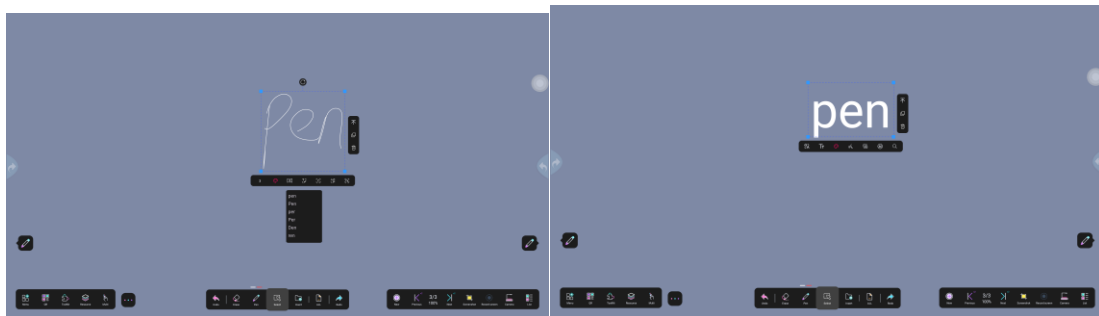

## ⑦ Supports mobile input

- Open Insert, click, and  scan the text with your phone

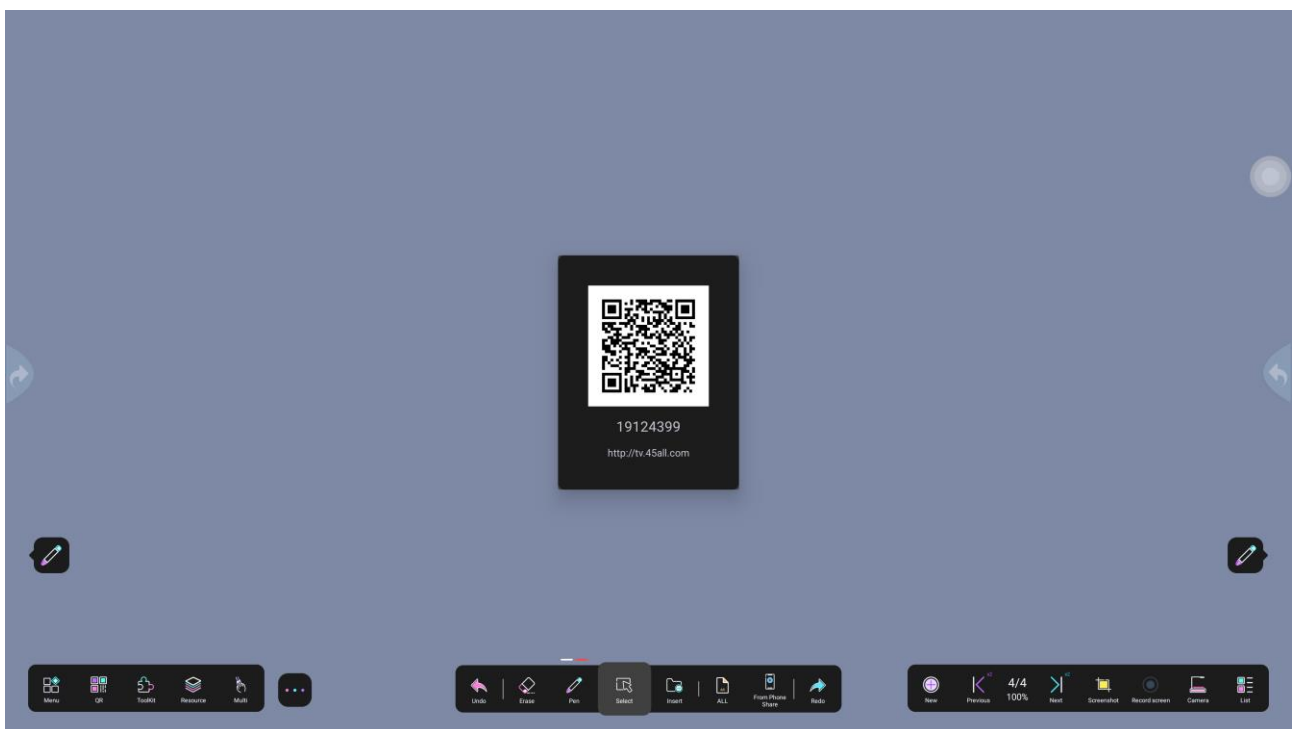

•Open the background image selection box. Scan the QR code below to insert images from your phone

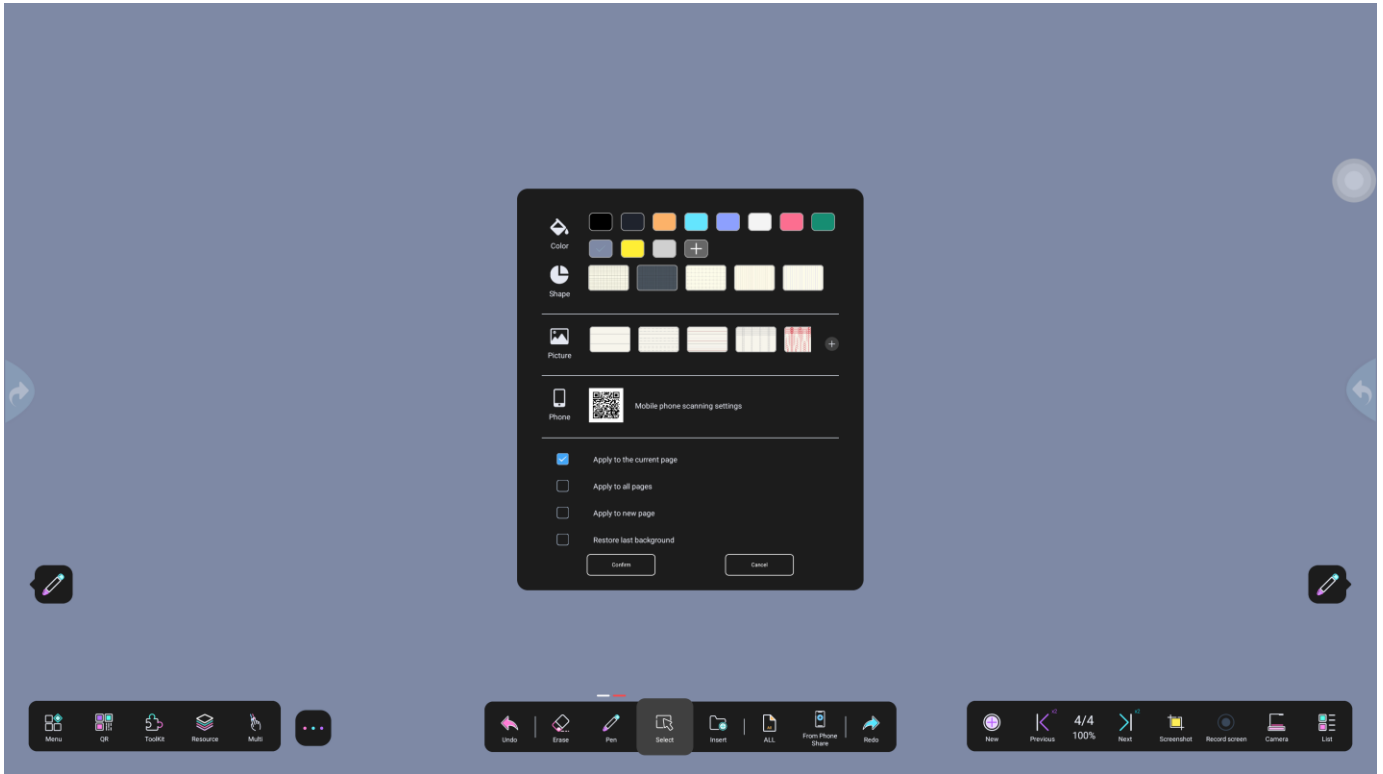

•Tap to enter  text on the keyboard.

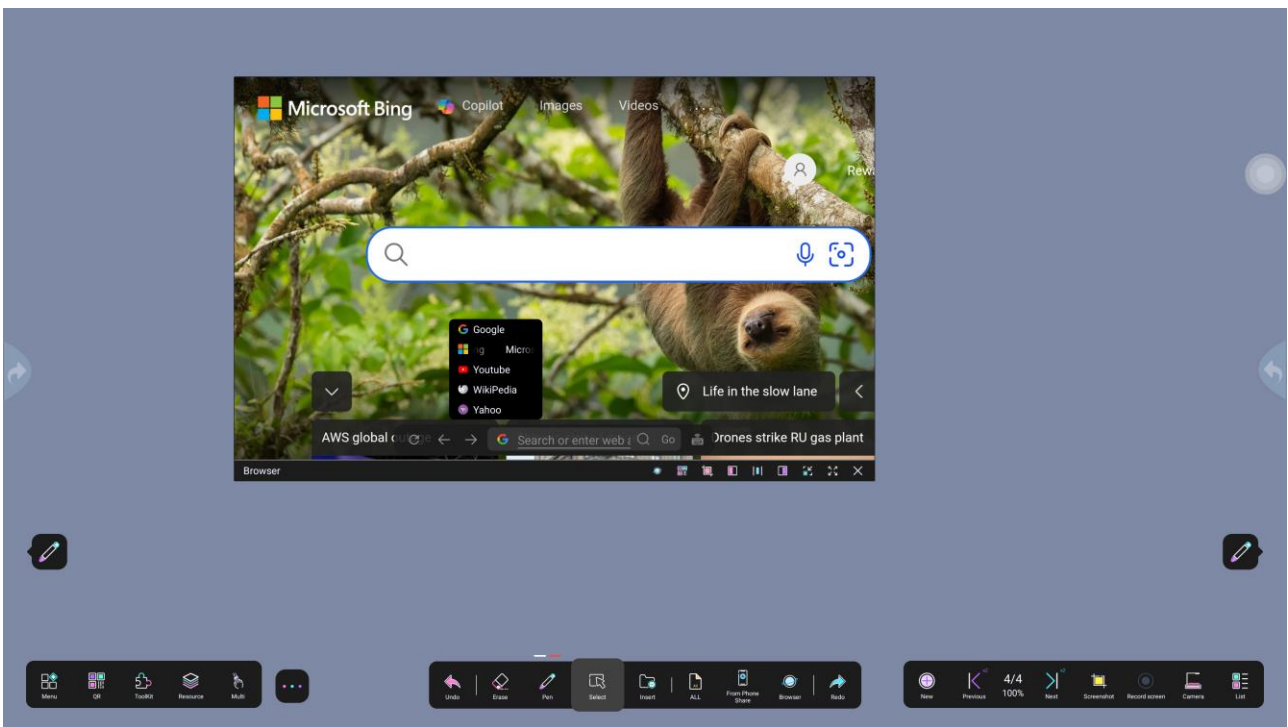

### ⑧ AI function

Click the AI icon with handwritten text or standard text to open the AI window, which includes AI

chat, AI-generated images/videos, browser, AI classroom course design, and AI Q&A.

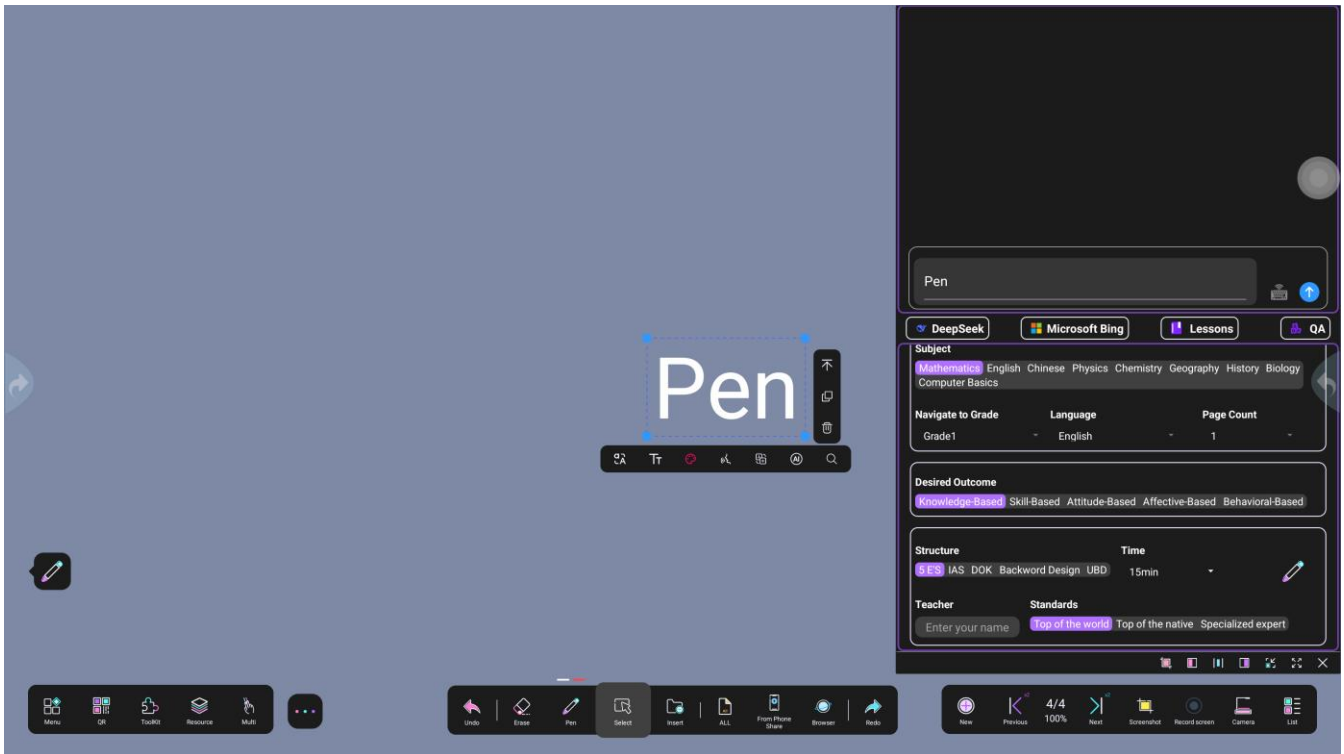

### ⑨ browser

To make it easier for users to use AI, you can also search. This feature supports switching between different search engines (such as Google, Bing, YouTube, etc.).

### 4.3.2.DMS

OEM customers and online upgrade users need to obtain the display's MAC address for later software modifications, debugging, firmware upgrades and remote control.

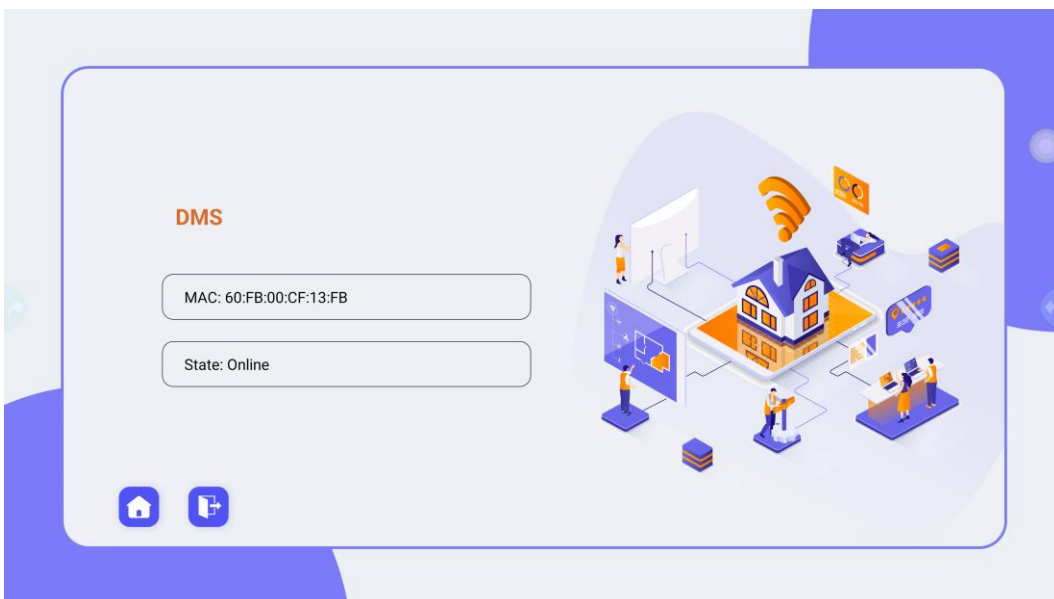

### 4.3.3.UFile

File Manager allows users to browse files stored in Android system memory or external storage devices connected to the display. It supports opening cloud resources, LAN operations, teaching scenarios, and desktop files.

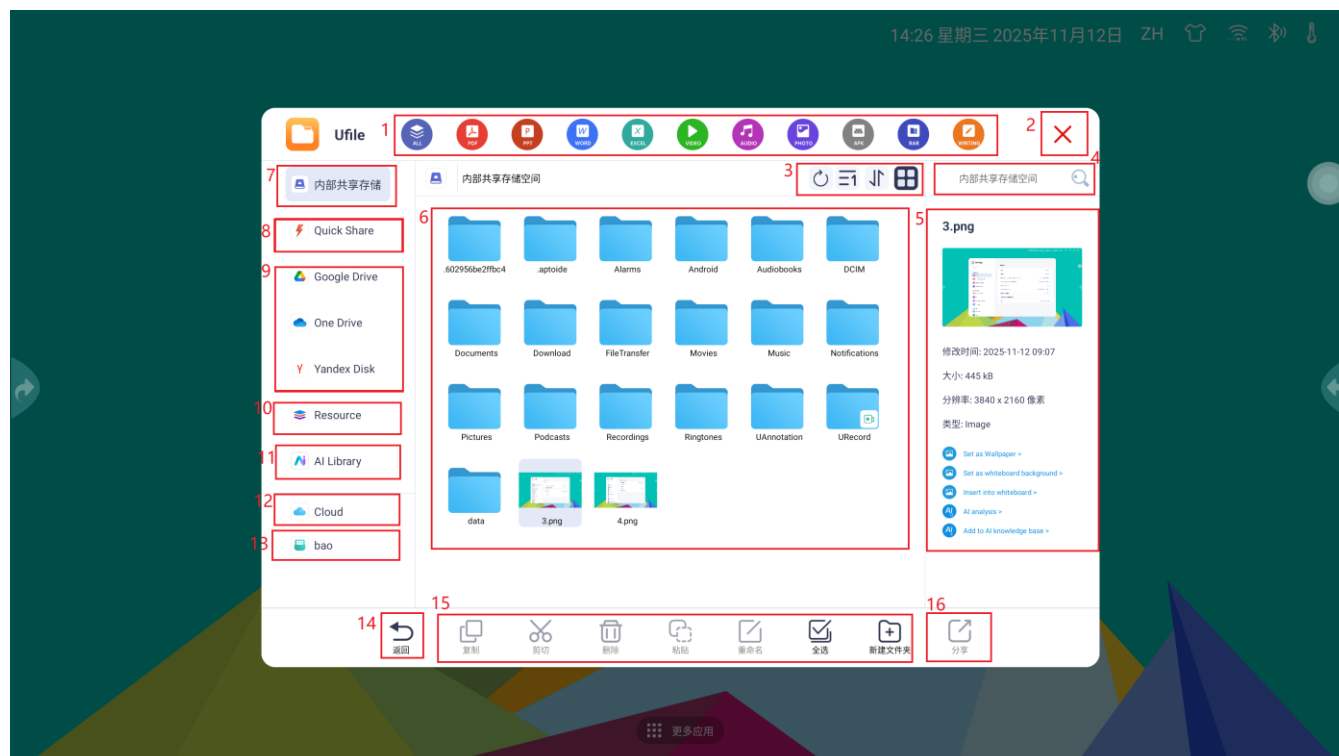

UFile Function Description

function	description
1. File Classification	All files, PDF, PPT, WORD, EXCEL, video, audio, images, APK, RAR, and WRITING
2. Exit	withdraw from UFile
3. Display Mode	Refresh, sort by ascending/descending, time/sized/type, list/icon display
4. Search	Enter keywords to search for the corresponding file
5. Document display	Displays the number of current files, excluding folders. Click a file to view it. Name, size, and other related information
6. Main display area	Display files in the current storage device. Double-click to open files.
7. Storage devices	Click to view files in the current storage device

8. Quick Transfer	Scan to upload shared files here
9. Google drive One Drive Yandex Disk	Sign in to the corresponding account to view uploaded files
10. Resource	Display public resources uploaded to the cloud platform, OEM resources corresponding to devices, and devices Resources under the logged-in teacher account
11. AI Library	Display AI knowledge base resources. The current interface resources can be used in AI Assistant. Application references
12. Cloud	You are logged in by default and can view uploaded files. Click Download to find the downloaded files in the local cloud folder.
13. External storage	Display the connected USB drive. Click to view the files on the USB drive.
14. Return	Go to the parent directory
15. Operation file	Copy, Cut, Delete, Paste, Rename, Select All, Create Folder
16. Share	Press and hold the selected file to share. The maximum file size is 50 MB. You can view the shared file in the Kuaichuan interface.

•file attributes :

Click the corresponding file or folder to view its properties on the right, including size, modification date, and file type. You can directly insert files into UMind from File Explorer, set UMind background, and configure desktop wallpaper.

•File preview:

Image preview supports common image formats such as PNG, JPG/JPEG, GIF, BMP, and WEBP.

Video preview supports common video formats such as MP4, 3GP, MKV, WEBM, AVI, MOV, WMV, FLV, HEVC, etc.

Text preview supports common formats such as TXT, MD, RTF, HTML/HTM, JSON, and XML.

File preview supports common text formats such as Doc, PPT, Excel, Xmind, 3D models, CAD, PDF, vector image models, Photoshop, and more.

•Quick Share:

Scan to upload files Quick share

Supports sharing local files, with sharing records in the Quickshare list. Select  an object and click "", then a QR code will pop up. Scanning the QR code allows access to the content. Another device can enter the sharing code in Quick Share, which will then receive the file.

- Cloud :

No login required. Click "upload" to select files from local or external storage and upload them to the cloud. After downloading, the files will be saved in the local cloud folder.

- Resource :

- Adding resources to the cloud platform will display here. Only OEM resources bound to devices, public resources provided by the super administrator account, and resources added by teacher accounts logged in to UFile are supported.

- AI Library :

- In Ufile, the file display area allows you to add files to the AI knowledge base, which the AI Assistant app can analyze, interpret, and organize.

- share :

Press and hold to select an object, then click Share to set the sharing time limit. Scan the QR code with your phone to receive the shared file.

### 4.3.4.tranScreen

- Tap to start tranScreen. This app lets you mirror your display on a smartphone or tablet, and the content can be shared and displayed with each other.

- Before launching the application, make sure the monitor is properly connected to the Internet.

- To use tranScreen on a large screen for the first time, you need to enter an activation key. Without an activation key, the software is unavailable.

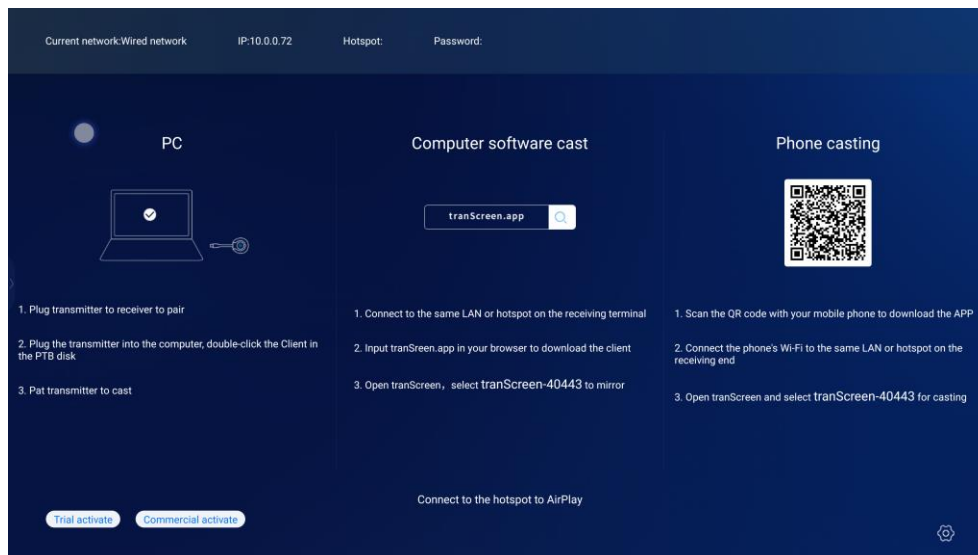

Use tranScreen:

1. Ensure your mobile device (such as a smartphone or tablet) and monitor are connected to the same network.

2. Scan the QR code to download and install the tranScreen app on your mobile device.

3. Open the tranScreen app on your mobile device and click the tranScreen ID name you want to connect to.

4. Mobile device successfully connected to the monitor.

5. After connection:

Tap to display two screen mirroring methods on mobile devices (one is to transfer the display to the mobile device, the other is to transfer the mobile device to the display).

Use a mobile device as a remote to control the display.

You can edit and comment on large screen displays on mobile devices.

You can also tap the Settings button in the lower-right corner of the large screen to modify tranScreen settings on your mobile device, such as tranScreen ID name, split-screen settings, and other options.

### 4.3.5. WPS software

Launch WPS. This application allows you to open document files, including PDFs, WPS Word, PowerPoint, Excel, images, videos, and other resource documents.

Edit files with WPS:

1. Tap the open folder icon on the left panel to browse and open files in your display memory, storage devices, or cloud storage.

2. Tap the function menu on the top panel to access various file format features.

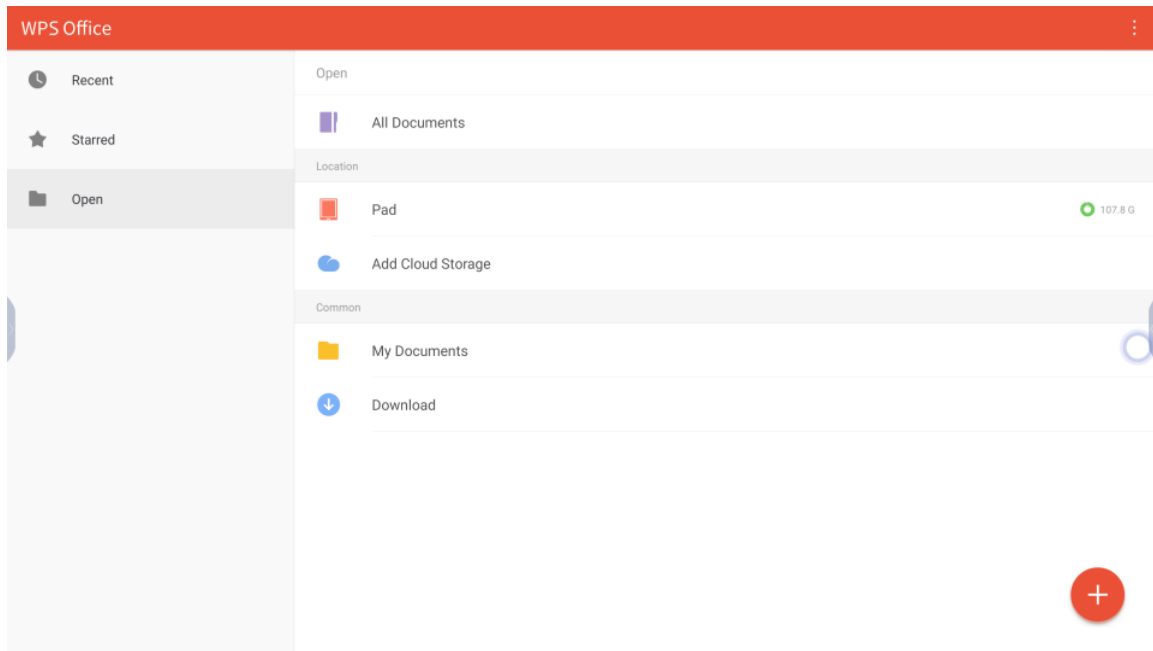

### 4.3.6.App Store

Open the app store interface to download apps, including [Premium Recommendations] and [Third-Party Software Recommendations]. Premium Recommendations feature our company-developed apps, while Third-Party Software Recommendations include commonly used third-party apps.

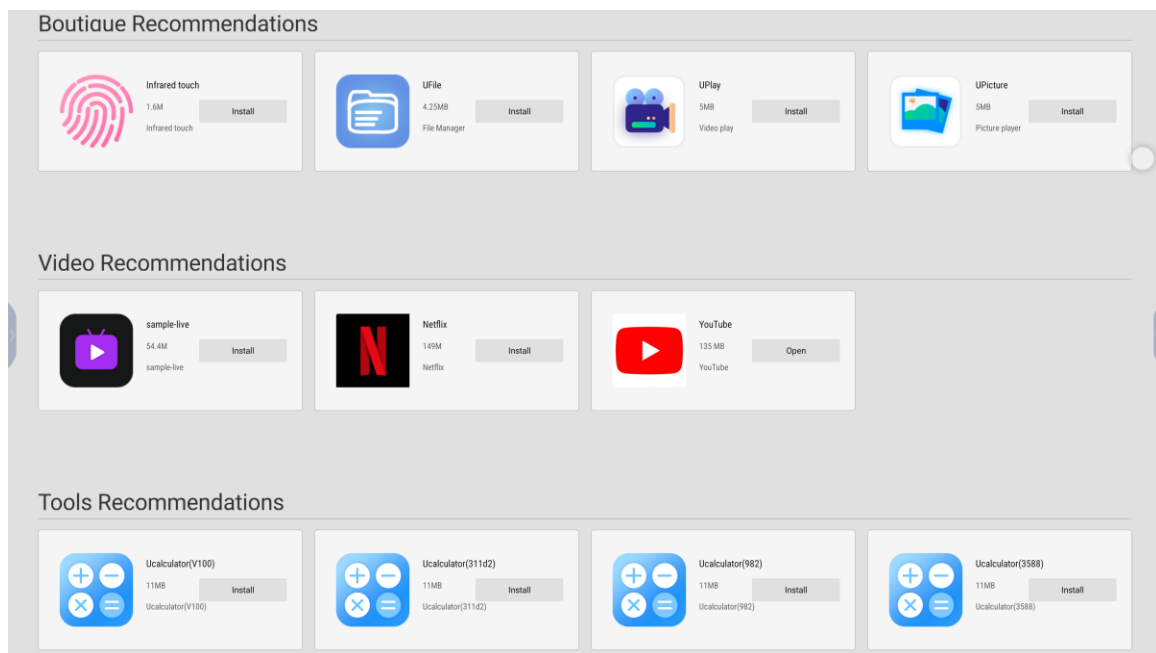

The banner area features our top-recommended software.

Only the display MAC addresses entered in our backend can access the app store.

### 4.3.7.UPlay Video Player

Launch the video player. Through this application, select the video file to play on the display and

perform any functions shown on the screen. Supports video formats (encoders/decoders) up to 4K resolution: avi, mov, mp4, etc.

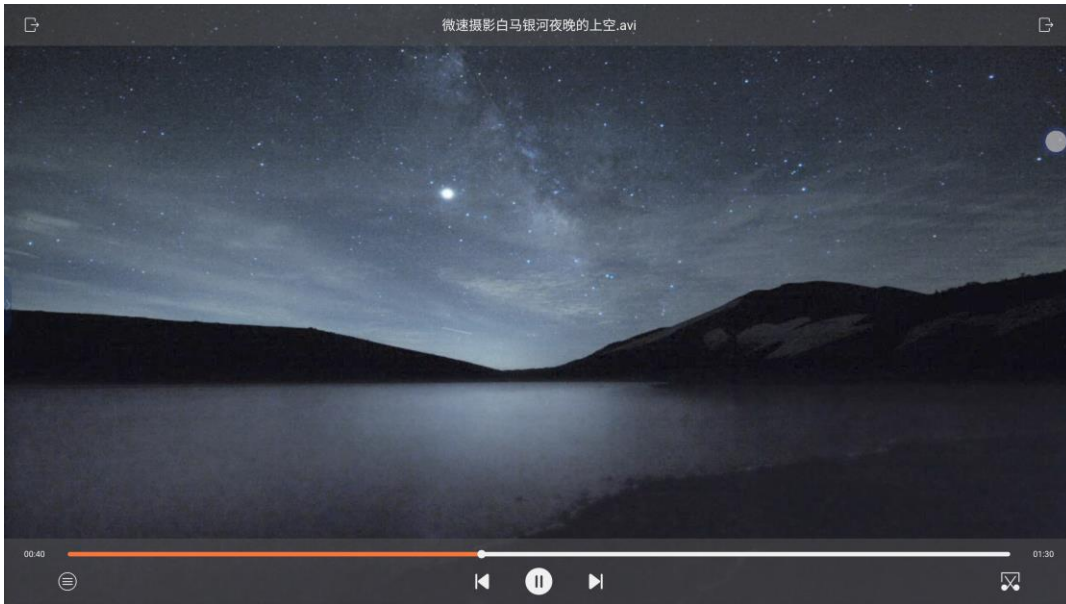

icon	function
	Play/Pause current playback
	Previous video
	Next video
	5s Back
	5s forward
	Multiple playback
	volume
	Loop Mode
	screen capture
	Playlists
	withdraw from

### 4.3.8.UFreeze

Now set-> Password Setting. Tap to activate the freeze screen software. Freeze screen freezes the

current interface to prevent accidental operations and adapt to specific scenarios. It presets several fixed modes and generates random codes for unlocking passwords.

Customize the screen lock password as shown in the following image:

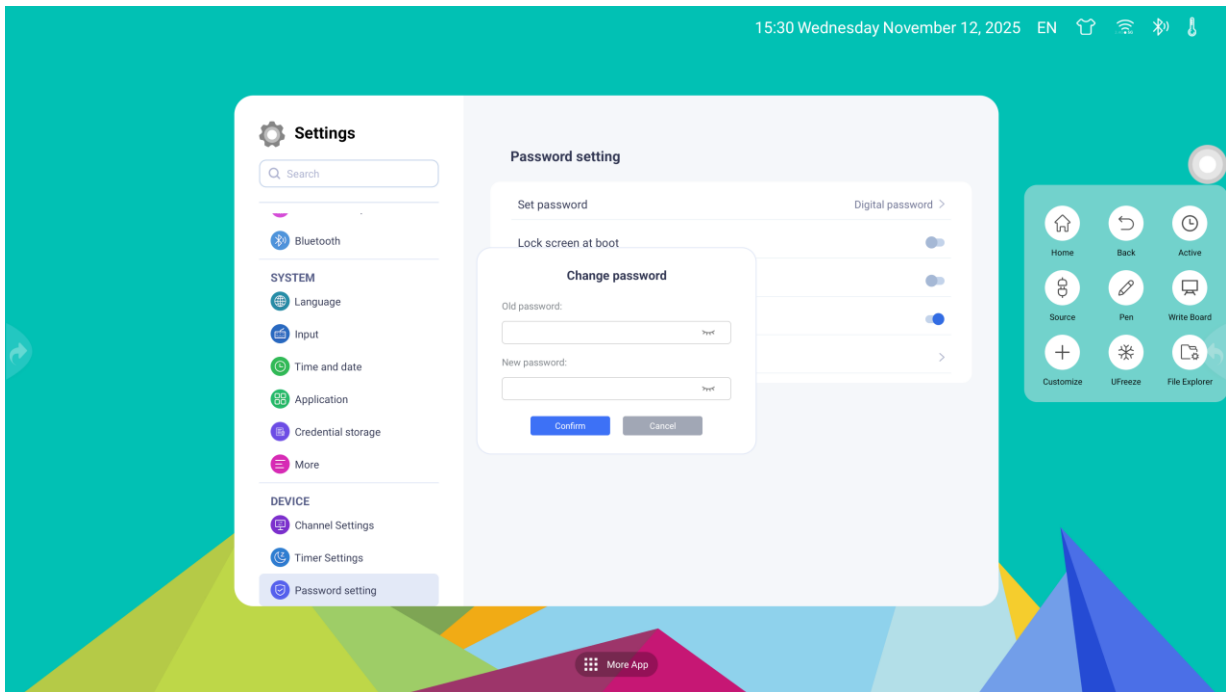

Scan the QR code with your phone, enter the lock screen password, and click OK to get a random password, as shown in the image below.

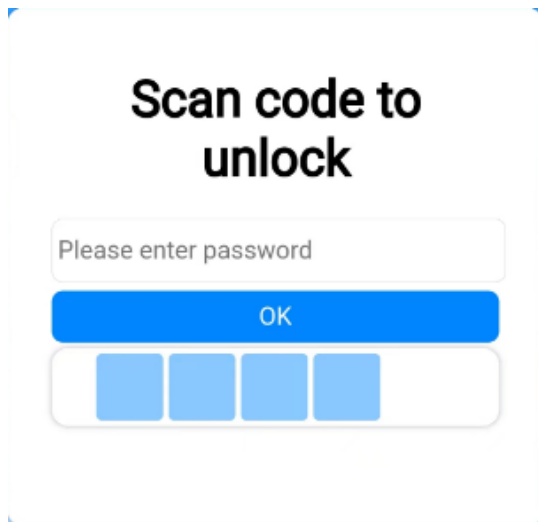

Enter a random password to unlock the screen, as shown below:

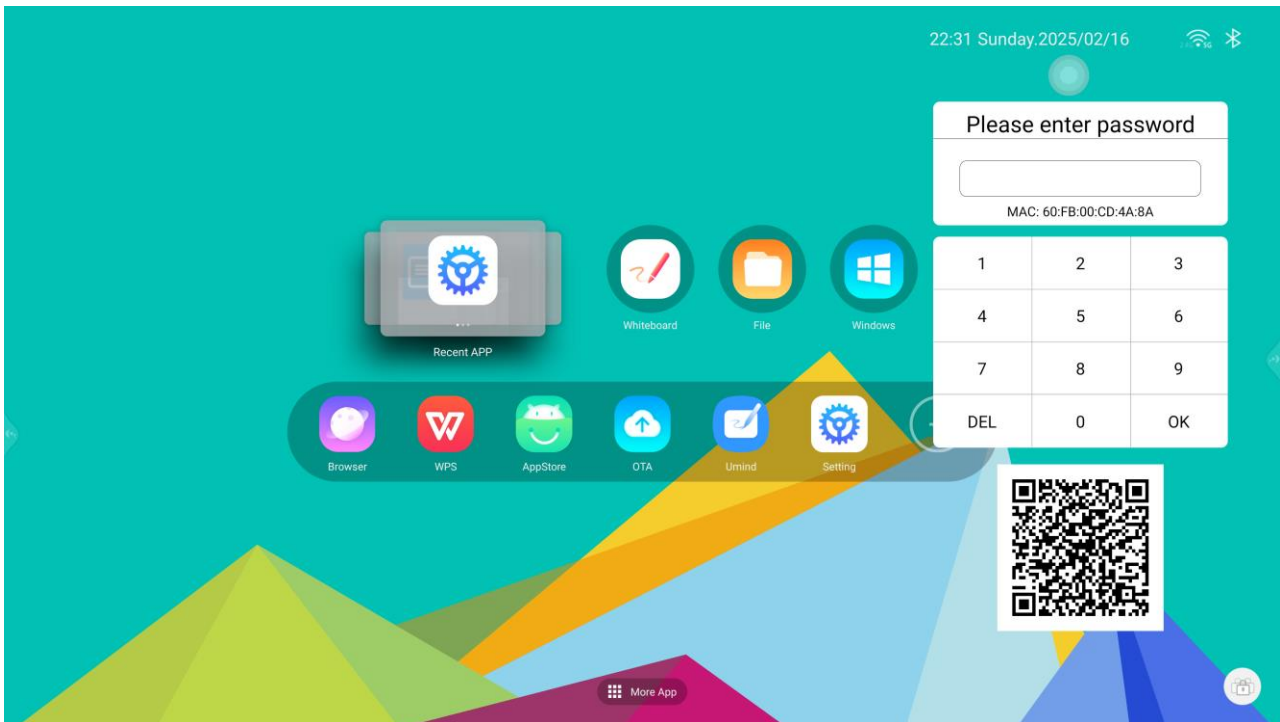

- Freeze this page: Freeze any page in any interface.
- Countdown: Use for exams or important events. Set any time within 1 hour.
- "Be quiet": Use for quiet situations, such as exams or important speeches.
- Ten minutes of break: for breaks during class presentations, breaks between sessions, etc.
- Assign homework: used when a teacher assigns subject homework.
- Custom: You can customize the frozen screen content. After writing, the frozen screen mode will be activated.



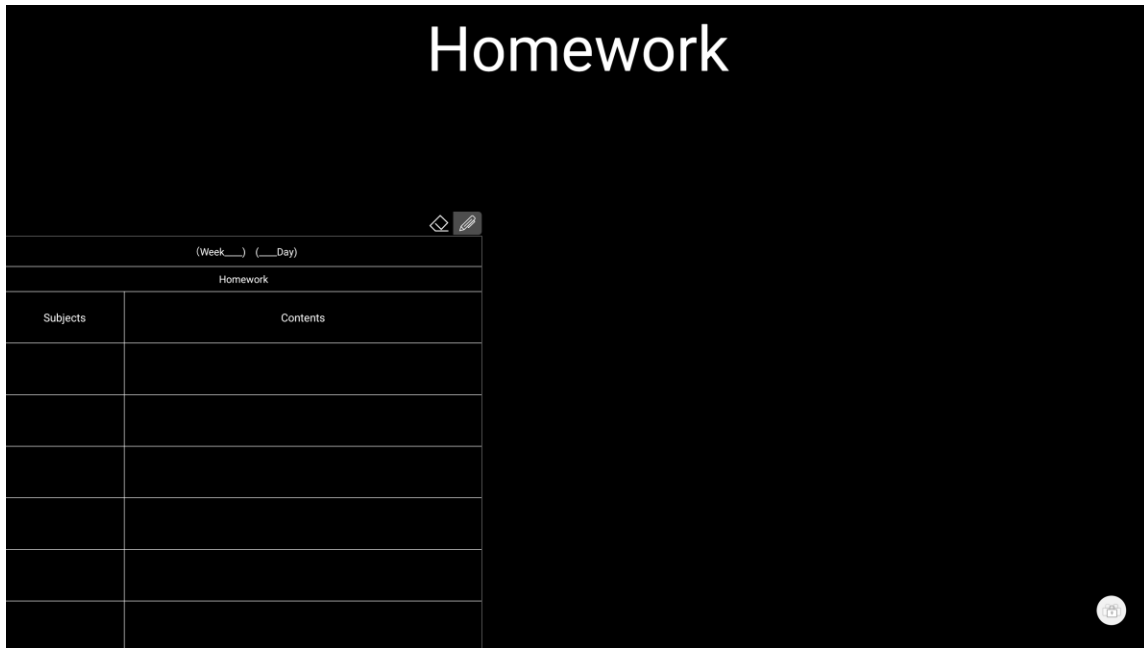

Set screen saver mode for assignments



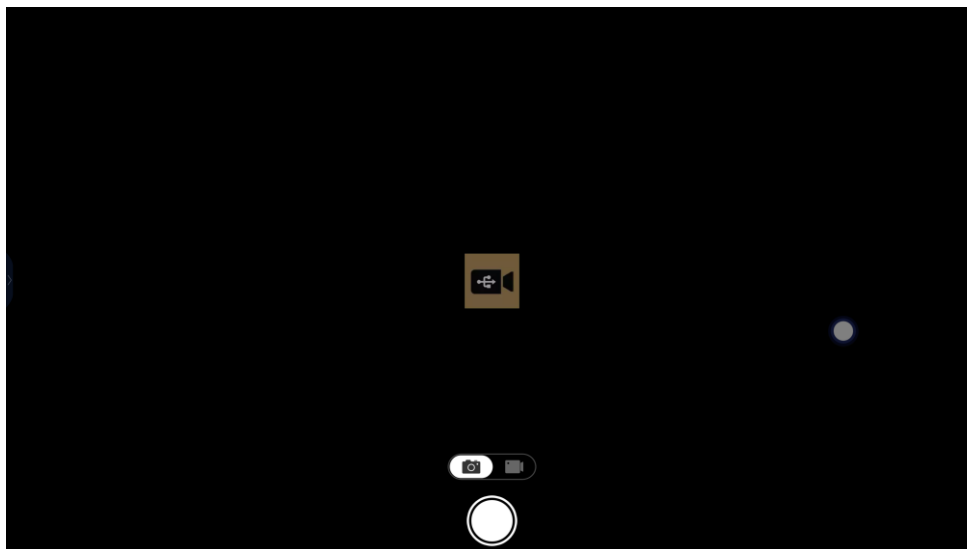

### 4.3.9. Camera

The AI camera supports both photography and video recording, featuring three modes: Panorama, Framing (also known as Meeting Mode), and Speaker (also called Tracking Mode).



order number	gesture	pattern	description
1		Panorama Mode	In this mode, the video displays the entire scene captured by the camera without zooming in, tracking people in the scene, or locating the sound source.

2		View Mode (Meeting Mode)	In this mode, the video displays the entire or partial footage captured by the camera. If there is no one in the frame, the display will switch to a panoramic view after 5 seconds. If one or more people appear in the frame, the camera will crop the image and select an appropriate area to frame all the people together.
3		Presentation mode (Tracking Mode)	In speech mode, a small PMP window displays the panoramic view while the main video shows either the current tracking close-up or an enlarged shot of several people. The PMP view dynamically adjusts to the speaker's location, tracking their movements and zooming in on them. When someone speaks, the system automatically locates the voice source and displays a close-up of the speaker, with the camera following their movements seamlessly.

### 4.3.10. Split Screen

- Split screen allows you to use two apps simultaneously. Tap Split Screen, add the two apps you want to use, and tap Confirm.
- The split-screen displays two apps, each occupying the left and right halves of the screen. You can switch between them and hold down the spacebar to adjust their positions.
- Tap × to exit split screen

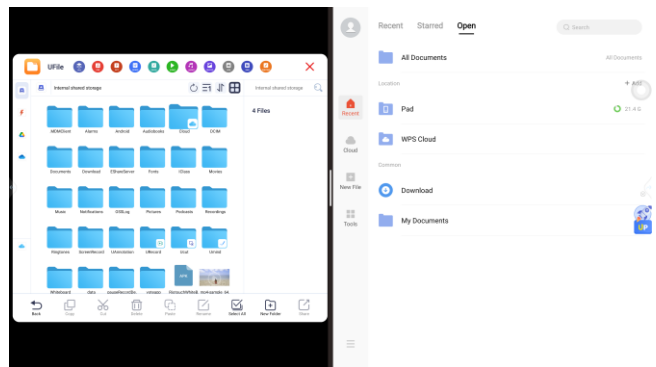
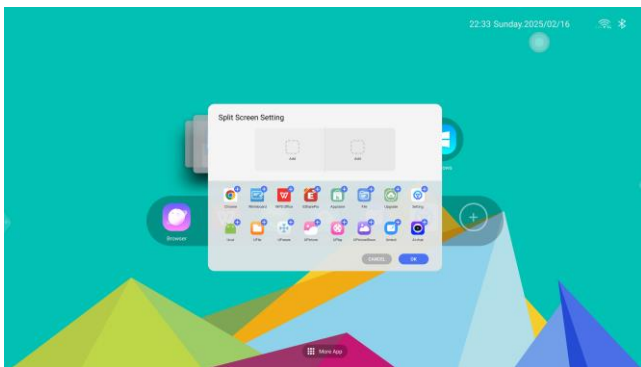

### 4.3.11. URecord

Record 4K videos with high resolution and customizable settings. After recording, click to generate a QR code to share the video.

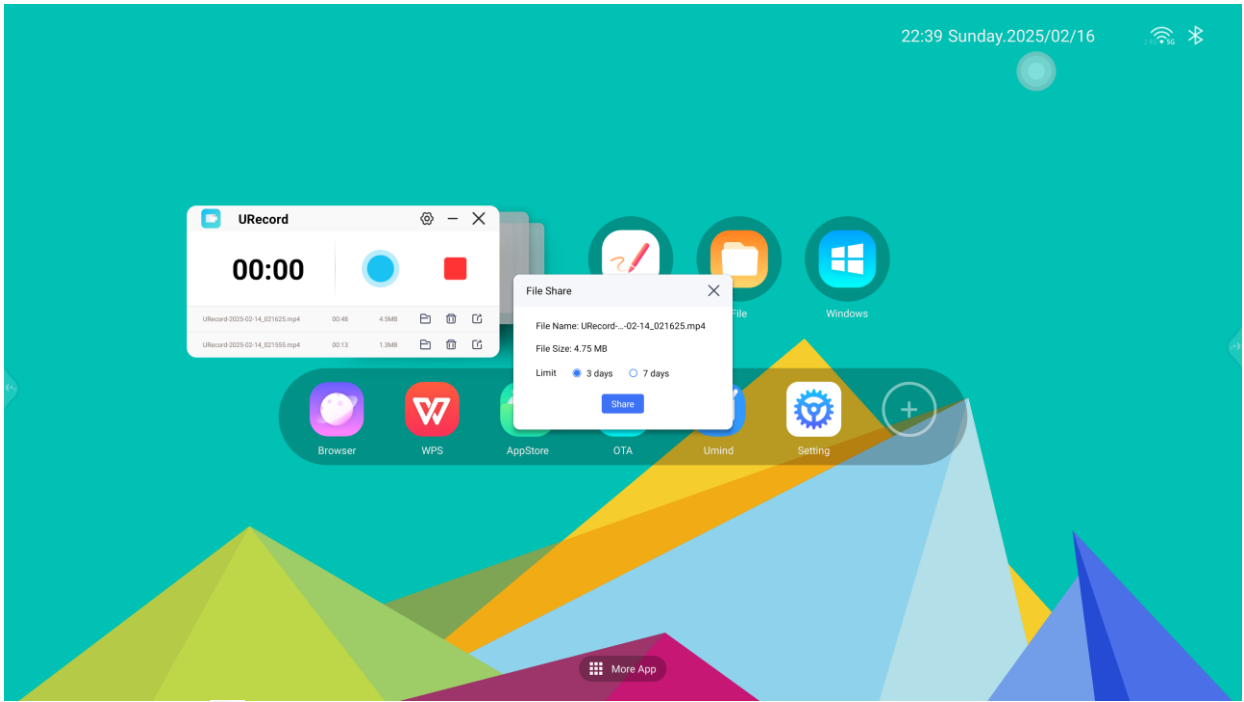

Click to locate  the current file with one click for easy playback

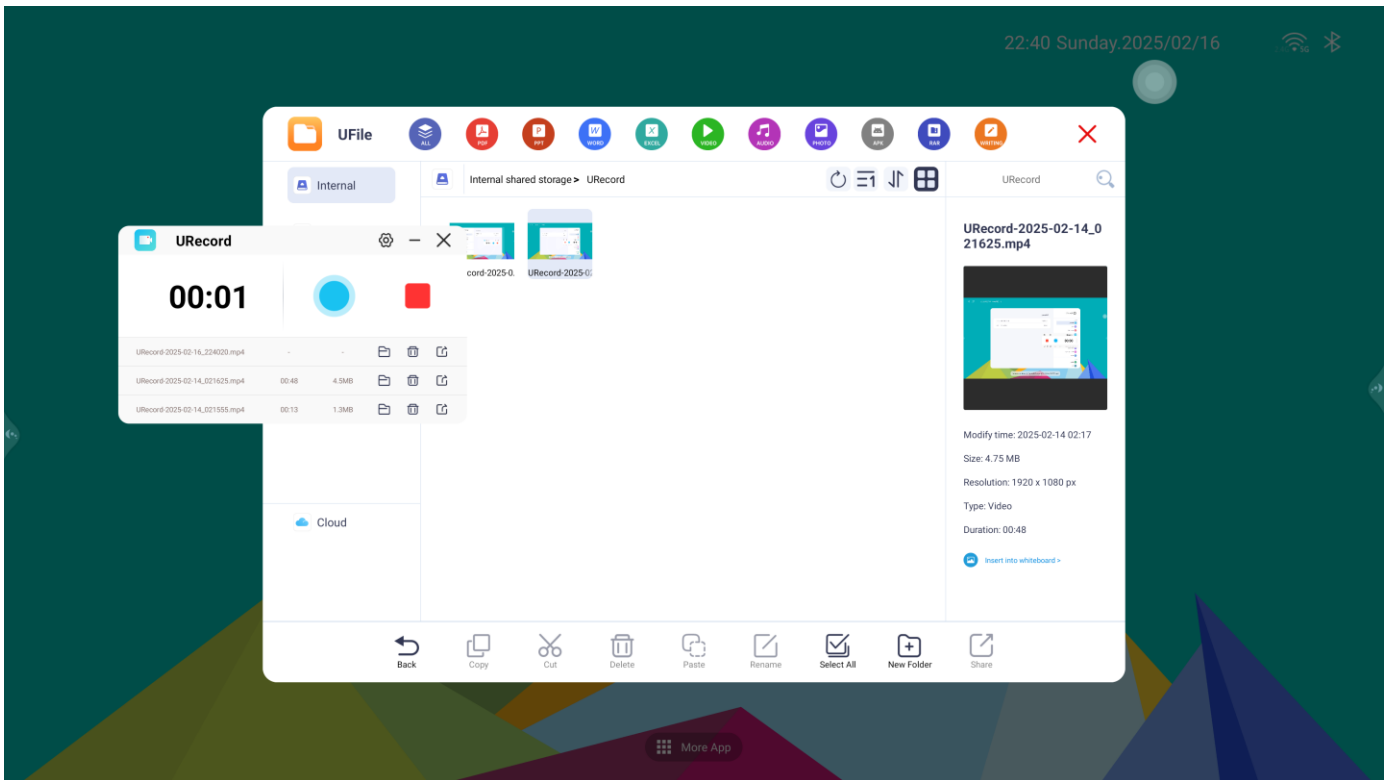

Supports opening two cameras

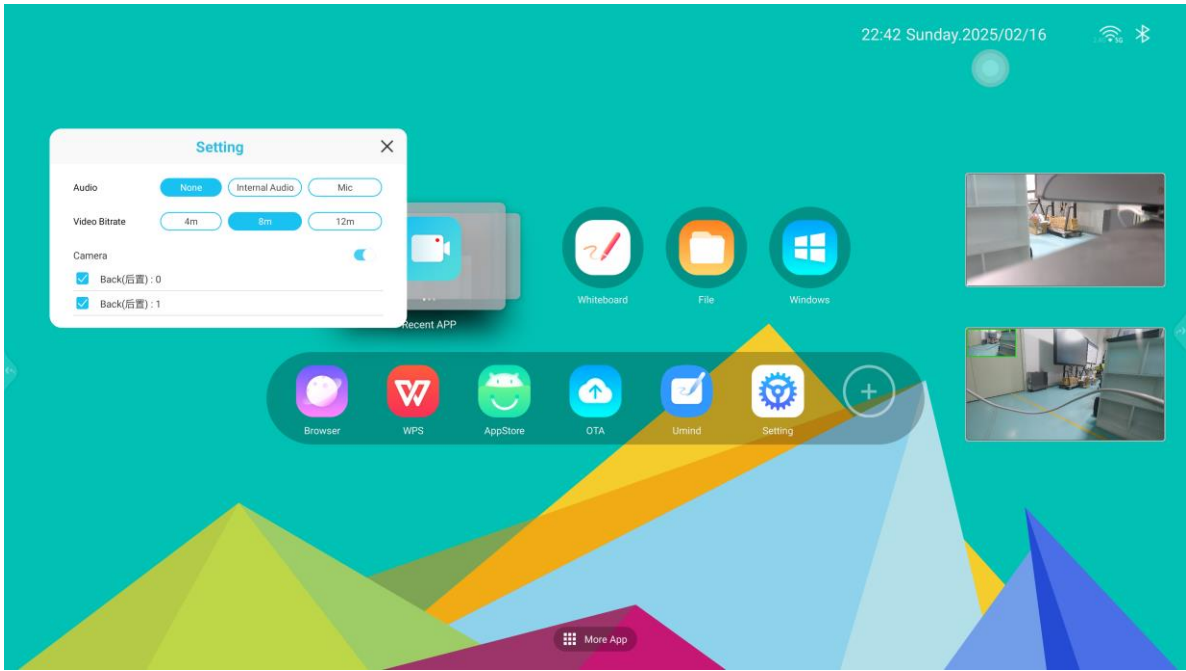

### 4.3.12. Ucut

Supports free, full-screen, and custom screenshot features, with prompts for inserting whiteboards and generating QR codes for sharing.

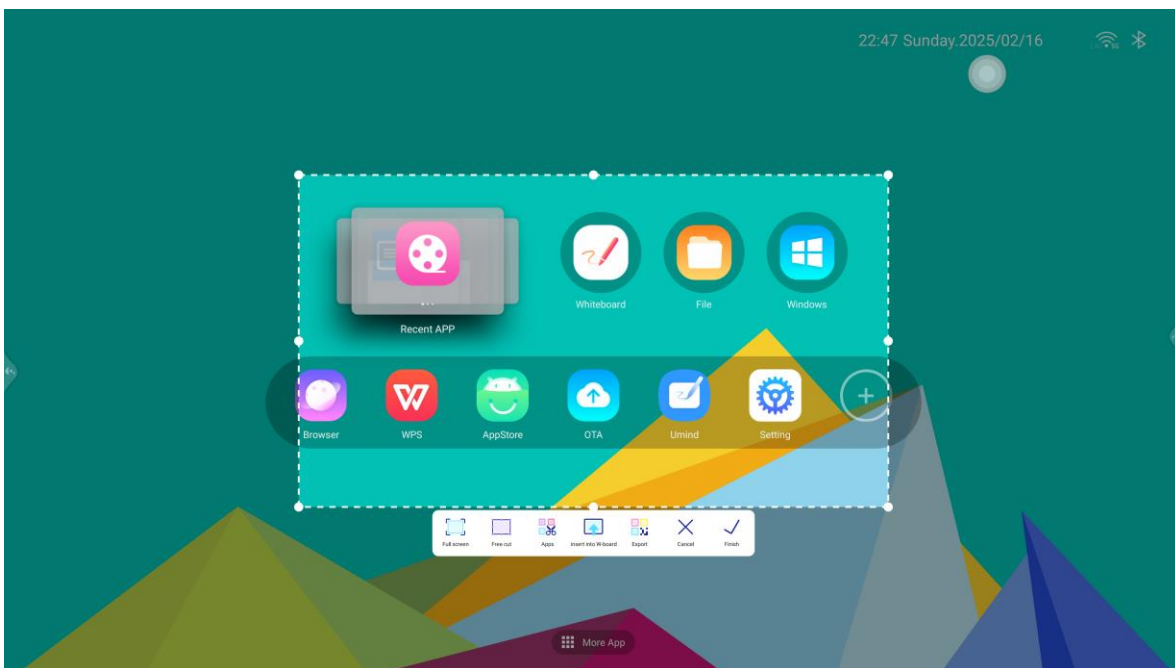

# 05 Warranty Terms (Three Guarantees Service Terms)

## Three Guarantees Service Policy

- This card serves as the warranty voucher for the touch-screen TV all-in-one unit and must be kept by the user. With this card and a valid invoice or other legally valid documents specified under the warranty policy, the user is entitled to repair, replacement, and return services in accordance with national laws and regulations (including the "Regulations on Repair, Replacement, and Return Responsibilities for Certain Goods", "Regulations on Repair, Replacement, and Return Responsibilities for Household Audio-Visual Goods", and "Regulations on Repair, Replacement, and Return Responsibilities for Microcomputer Goods", collectively referred to as the "Three Guarantees").
- This card cannot be reissued if lost. Please keep it safe and show it when requesting warranty services.
- This card shall not be liable for any other liability, including but not limited to occasional or consequential damage or loss of anticipated benefits or profits, or any liability arising from the cessation of work or damage caused by the use or inability to use the product.
- This card shall not be liable for any other liability, including but not limited to occasional or consequential damage or loss of anticipated benefits or profits, or any liability arising from the cessation of work or damage caused by the use or inability to use the product.
- When applying for the three guarantees service with this card, please back up your programs and data in advance. If you use the system recovery CD for maintenance, you cannot restore user-installed programs or generated data. Service outlets are not responsible for any browsing, modification, deletion, or alteration of product content, and cannot restore or retain your personal programs and data.
- The parts replaced in the three guarantees service will not be returned to the user.
- The calculation method of the validity period of the three guarantees service shall be subject to the three guarantees regulations.
- If the contents recorded in this card are inconsistent with the relevant laws and regulations of the state, the relevant laws and regulations of the state shall prevail.

## The three guarantees service is not implemented

- The cardholder shall not present valid invoices or other valid certificates stipulated in the three guarantees and this card (except those who can prove that the product is within the three guarantees period according to the three guarantees).
- The product bar code is damaged or altered;
- The card has traces of alteration or the recorded product information is inconsistent with the actual product;
- Natural consumption, wear and tear and aging of consumable materials;
- Failure caused by lightning strike or other power system causes;
- Failure caused by force majeure such as accident, disaster or war;
- Modifications or repairs made by oneself, or disassembled, modified or repaired by a third party without authorization;
- Software failures of non-product peripherals or accessories used with the product and resulting in product failures; usage failures of third-party software not pre-installed on the product and resulting in product failures;
- The failure is caused by improper use or storage such as liquid injection, moisture, external force compression and drop;
- Using pirated software or being infected with viruses during use, resulting in failure;
- The situation does not conform to the provisions of the three guarantees;
- The warranty period has expired;
- Failure to use, maintain or keep the product as required by the instructions;

Warranty validity period	Full machine: 1 year
main unit	Display, touch screen, OPS computer (optional)

Warranty area	Valid only in mainland China (excluding Taiwan, Macau, and Hong Kong)
Warranty coverage	Main unit and other items are subject to the three guarantees regulations

# 06 product certification

---

---

